

Rapidly Deployable Radio Networks Network Architecture

Stephen F. Bush, Sunil Jagannath, Ricardo Sanchez,
Joseph Evans, Victor Frost and Sam Shanmugan

July 1, 1997

Abstract

This is a specification for the network architecture and functionality of the Rapidly Deployable Radio Network. Invariants for each protocol layer, as well as configuration, reconfiguration, link quality, and mobility are specified. Implementation of high level functionality is prioritized, while refraining from over-specifying some of the interesting areas of research. Existing standards and areas of research are identified providing a framework for the development of the RDRN network architecture.

1 Introduction

This is a specification of the network architecture, components, and functionality for the Rapid Deployment Radio Network. This specification attempts to be independent of implementation details such as where and how functionality is implemented. Functionality is rated as mandatory, high priority, or optional. Mandatory functions will be implemented, high priority functions may be implemented if time permits, and optional functions have a low probability of being implemented. Within each functional area the relevant standards and proposals are noted as well as assumptions and open issues. The logical system components for the Edge Node (EN) are shown in Figure 1 and the components for the Remote Node (RN) are shown in Figure 2. The components include a high speed radio and directional antenna for EN-EN connections, medium speed radio and directional antenna for EN-RN connections, and a processor with a Linux operating system for configuration and link quality processing.

The implemented system will consist of Edge Nodes (EN) and Remote Nodes (RN) as shown in Figure 13. The RNs are mobile host nodes. A more detailed view of the system is shown in Figure 3. The Edge Nodes (EN) are shown as dashed boxes and consist of at least one Edge Switch (ES) and may contain an ATM Switch. The ES has the capability of switching ATM cells among RNs or passing the cells on to an ATM switch for faster switching for the higher speed

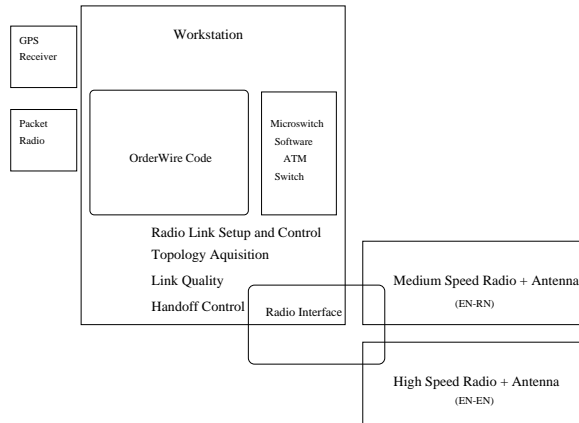

Figure 1: Edge Node Components.

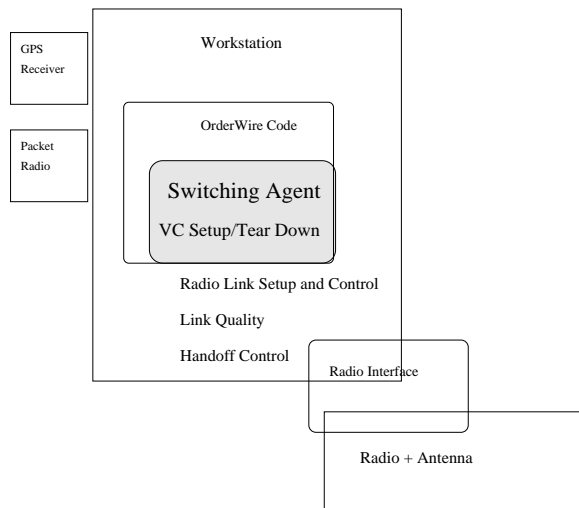

Figure 2: Remote Node Components.

EN-EN connections. The anticipated protocol stack for the high speed network is shown in Figure 4. Note that the differences between an ES and RN are that the ES performs switching and has the capability of higher speed radio links with other Edge Nodes.

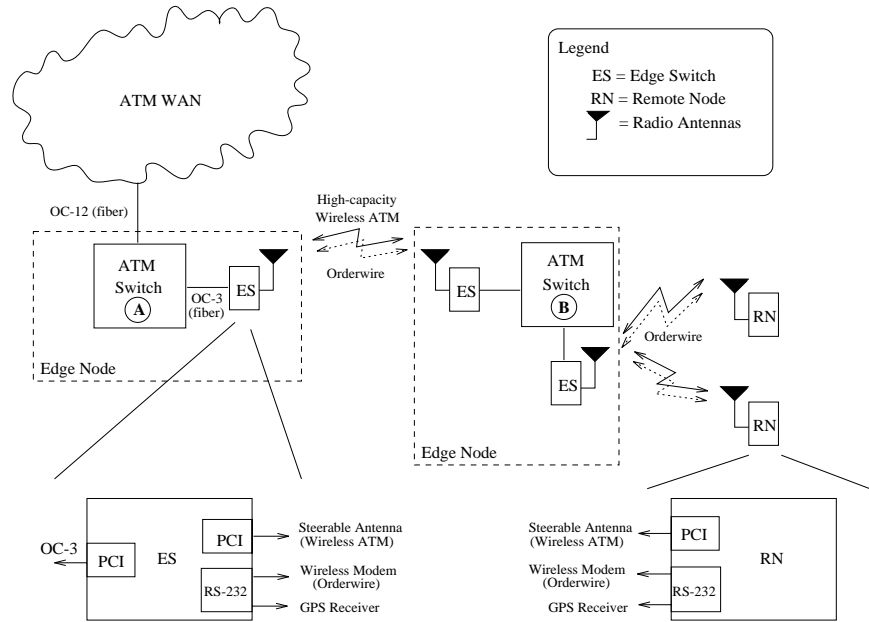

Figure 3: Edge Nodes and Edge Switches.

A goal of the original design was to keep the wireless component as simple as possible. It would be attached to an existing ATM switch through a single port creating a node which could reside at the edge between a fixed and wireless network. However, well known VCs such as 1 (GSMP) 5 (Q.2931), and 16 (SNMP) would overlap for all remote hosts. It was decided to incorporate switching into the wireless interface, thus eliminating the need for the ATM switch. Because the wireless interface has switching capability, overlapping VC space is not a problem and RN to RN connections at the same base station can be connected directly together without having to go through the ATM switch. A disadvantage of incorporating ATM switching into the wireless interface is that the extra features incorporated in ATM switches, such as topology acquisition, RVCs, LAN Emulation, Switching Agent, etc... will not be available without significant additional development effort.

In order to make the problem more tractable, Sections 2 through 8 focus on a static wireless network, e.g. RNs remain associated with a single ES; no handoffs take place. The remaining sections handle dynamic mobile networks.

1.1 Terminology

Remote Node The Remote Node (RN) is a wireless mobile host.

Edge Node The Edge Node (EN) is shown as the dashed box in Figure 3. It is defined as a the smallest unit which performs switching and contains all adjacent wireless links.

Edge Switch The Edge Switch (ES) is shown in Figure 3. It resides at the edge of the wired and wireless networks and has the capability of switching among adjacent RNs. When used at the edges of an EN-EN link, it requires a directly connected ATM switch. This is because the higher speed EN-EN links will require faster switching.

1.2 General Requirements

- Separation of protocol layers should be maintained. (high priority)
- There should not be a single point of failure in the design. (high priority)
- Standards should be used where possible. (mandatory)
- A variety of traffic types must be supported, e.g. CBR, VBR, ABR. (mandatory)
- There will only exist one link level hop from any ES to its associated RN. (mandatory)
- The Linux operating system will be used for the network control protocol and the high speed protocol stack.

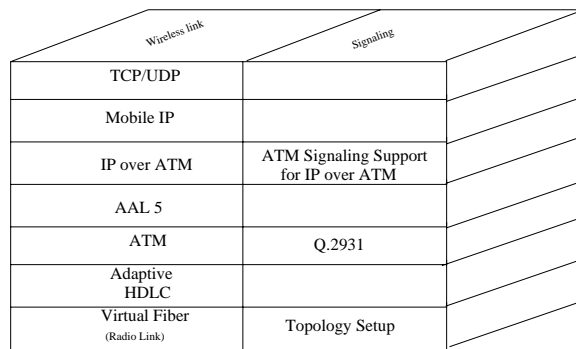

Figure 4: High Speed Protocol Stack.

2 Physical Layer

The physical layer includes all hardware components and the wireless connections. This includes the high speed radios, orderwire packet radios, ATM switch, antennas, and additional processor for configuration and setup (orderwire). This layer provides a raw pipe for the data link layer described in the next section. Configuration at this level is described in Section 8.

2.1 Physical Layer Requirements

- Edge nodes/Remote nodes must be able to automatically establish radio connections. (mandatory)
- RNs should be capable of establishing two physical connections to separate ESs simultaneously, i.e. dual homing. (optional)
- RNs should be able to connect with the ES which provides the best QoS. Section 7 discusses link quality. (mandatory)
- There should be a mapping between the port and an ATM VCI. A port is a time slot, set of complex weights, link quality, and frequency that defines the physical connection between the switch and the end-user. (mandatory)
- A directional beam is formed at the desired steering angle during transmit using complex weights implemented by look-up tables. (mandatory)
- Beamforming should take place at IF (10 MHz). (mandatory)
- There should be a minimum of 180 degree coverage. (mandatory)
- There should be at least two beams from a single antenna. (mandatory)
- TDMA will be used within a beam. (mandatory)
- There should be the capability of at least two users per beam. (mandatory)

2.2 Assumptions

- Switches will always be able to determine at least one fully connected configuration.
- RNs traveling out of range during a session will result in forced termination of the session.

2.3 Open Issues

- Will beamforming be used on receive using DSP?
- Will coverage expand to 360 degrees?
- How will adaptive coding, power, and modulation be implemented?
- How much interleaving of data should exist, and can this be a dynamic parameter?
- Will synchronization time cause too much overhead and can the number of times synchronization is required be reduced ?

3 Link Layer

The link layer in this section will comprise all protocols which support the ATM layer. The wireless data link layer will be adaptive to provide an appropriate degree of data rate versus reliability in order to properly support the various types of ATM traffic. For example, we may want to drop voice packets, which are very time sensitive, but retry data packets. The edge interface unit has some knowledge of the requirements of each traffic stream. For example this knowledge can be obtained from VC identification. The efficiency of the data link layer will be improved by using this knowledge.

In this architecture ATM will be carried end-to-end. However, at the edge between the wired (high-speed) network and wireless links, multiple ATM cells will be combined in an HDLC-like frame. For some types of traffic, error correction may be achieved using retransmission. Here, delay is increased for this class of traffic to prevent cell losses. It is well known that even a few losses can have a significant impact on the performance of TCP/IP, while TCP/IP can cope with variable delays [1]. The HDLC-like protocol can change in response to traffic requirements. ATM end-to-end provides the following benefits:

1. Moderate cut-through, e.g. an IP segment may contain 8192 bytes or about 170 cells, while one ATM HDLC-like frame will contain on the order of 3-20 cells
2. ATM is a standard protocol.
3. ATM can incorporate standardized QoS parameters based on such things as VC number.

The link layer must also maintain cell order; this will be critical during handoff of an RN from one ES to another. This is covered further in Section 10. Figures 5 and 6 show the architecture for the link/ATM level implementation. Below the device independent ATM layer are the high speed packet radio (PR) specific layers. The RN/ES interface bridges at the cell level, not the AAL layer. No link level addressing is used since the ATM level specifies the address.

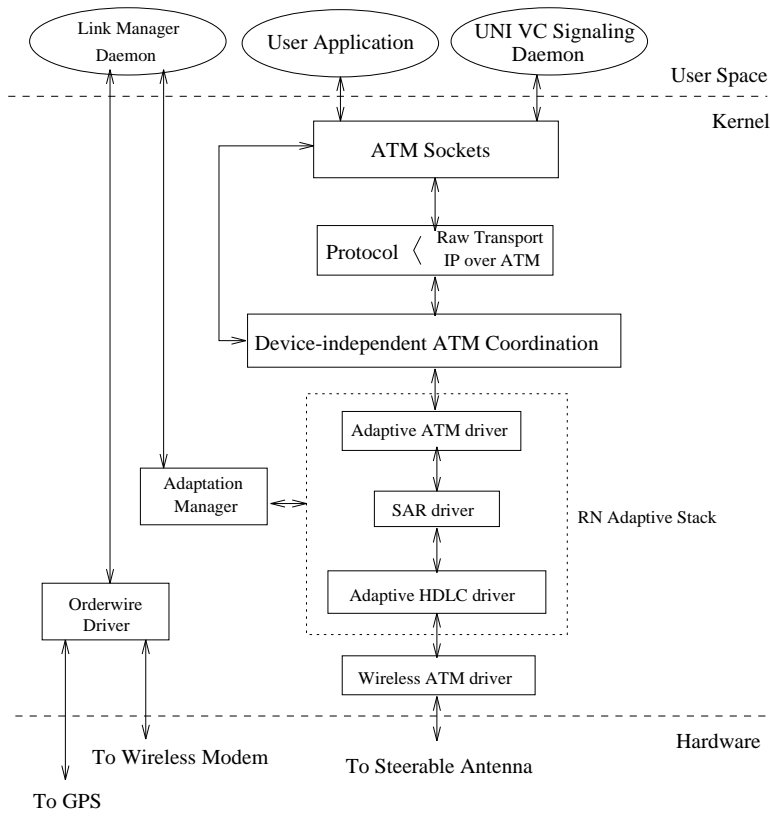

Figure 5: RN Network Protocol Stack.

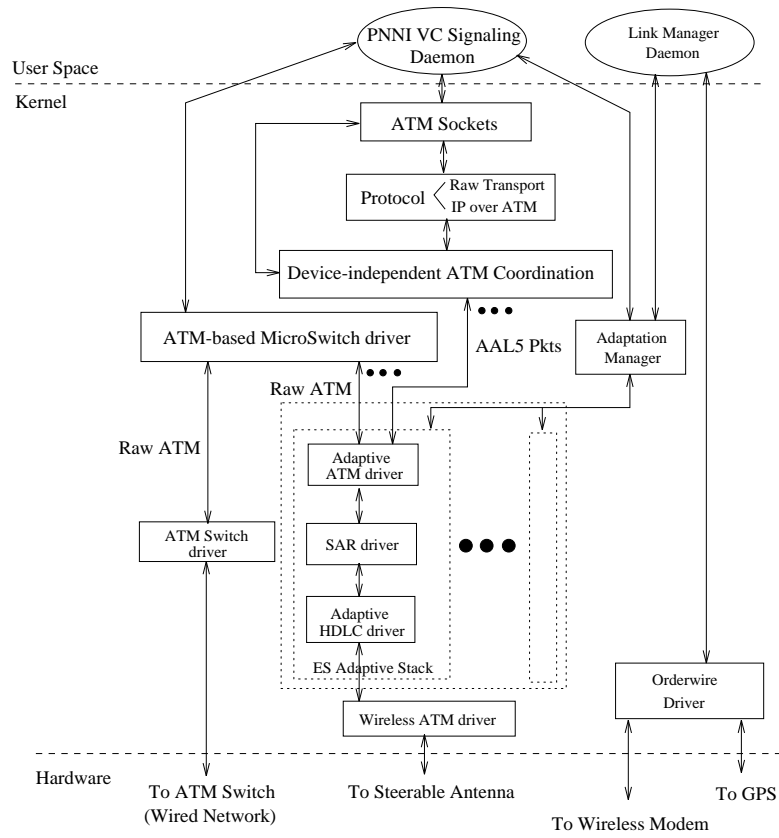

Figure 6: ES-Network Protocol Stack

3.1 Link Layer Requirements

- The wireless links will use HDLC-like framing as shown in Figure 7. (optional)

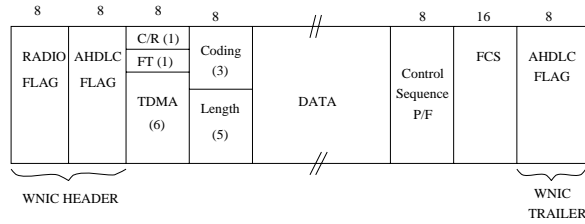

Figure 7: Basic HDLC-like Frame Format.

- ATM cell order must be maintained at all times. (mandatory)
- The network control protocol (NCP) as defined in Section 8 will indicate the links to be established. See Figure 8. (mandatory)
- The HDLC-like frame size will be from 3-20 ATM cells based on fading effects and multipathing. (mandatory)
- The RN/ES interface bridges at the cell level, not the AAL layer. This allows the use of other AALs besides AAL-5. (mandatory)

3.2 Assumptions

An HDLC-like link layer will be used between ES-to-ES links as well as ES-RN links. ATM packets and radio parameters will be encapsulated within the HDLC-like frame. Link-up and link-down will be determined using the same mechanism as AX.25; a timer which checks the link status at periodic intervals.

3.3 Open Issues

- What will be the exact structure of the HDLC-like frame headers ?
- Will there be a mechanism to insure that time sensitive cells are not delayed by processing of non-time sensitive cells ?
- Soft vs hard handoff needs to be evaluated. Soft handoff will allow an RN to maintain two connections for a single session simultaneously. This ensures that the session will not be cutoff at any point during the transition from one ES to another. Hard handoff simply breaks the connection with the transitory ES and establishes contact with the new ES, causing the session to be broken for a finite period of time.

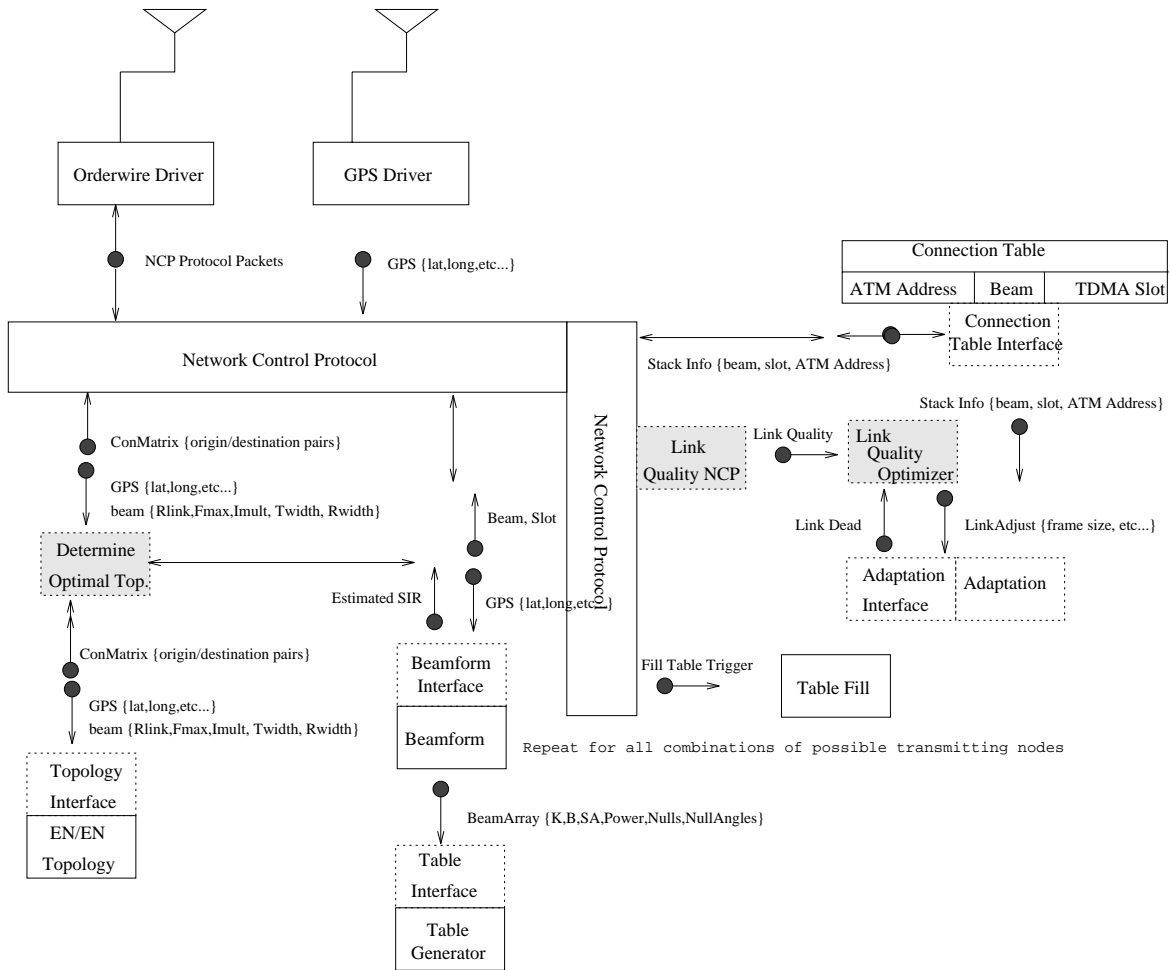

Figure 8: Network Control and Data Link.

- Adaptivity of the link layer needs to be defined. Frame Size and Retransmission have been identified as being adaptive.

4 ATM

This section deals with ATM layer issues. Address resolution is discussed in Section 5. This section is concerned with a static wireless environment, i.e. assuming no hand-offs take place. ATM signaling, routing, and maintaining cell order are some of the critical areas that will be affected by mobility. All of these issues are related to the mechanism used for handoff of an RN from one EN to another which is considered in Section 10. The protocol on the ES will remove ATM cells from the HDLC-like frames and switch them to the proper port. It will also pack ATM cells into an HDLC-like frame to send to the radio. Figure 9 shows the Linux environment on the RN. Note that dashed boxes represent code that has not yet been developed. The ATM Device Driver API and HDLC-like Driver are detailed in Figures 5 and 6.

A detailed view of the proposed software architecture for the ES is shown in Figure 10. There is one Packet Radio driver for the antenna with multiple ES Adaptive drivers, one per RN. The ATM Microswitch is shown in the middle of the ES. The Microswitch performs software ATM cell switching. Note that an ES connecting a wireless EN-EN will only have a single ES Adaptive driver and will contain a special version of the ATM Microswitch which will simply pass through ATM cells. In this case the ES-ES link would require a directly connected ATM switch.

4.1 ATM Layer Requirements

- The mobile ATM layer must be fully compatible with fixed network ATM. (high priority)
- “Standard” ATM call setup signaling must be used. (mandatory)
- Switched Virtual Circuits must be used. (mandatory)
- No AAL should be precluded from use, although AAL-5 will be used for IP data. (mandatory)
- Linux ATM [2] will be used to implement ATM and signaling. (mandatory)

4.1.1 ATM Signaling

- ATM Signaling Support for IP over ATM [3] will be used. (mandatory)
- Switched Virtual Circuits using Q.2931 [4] will be used. (optional)

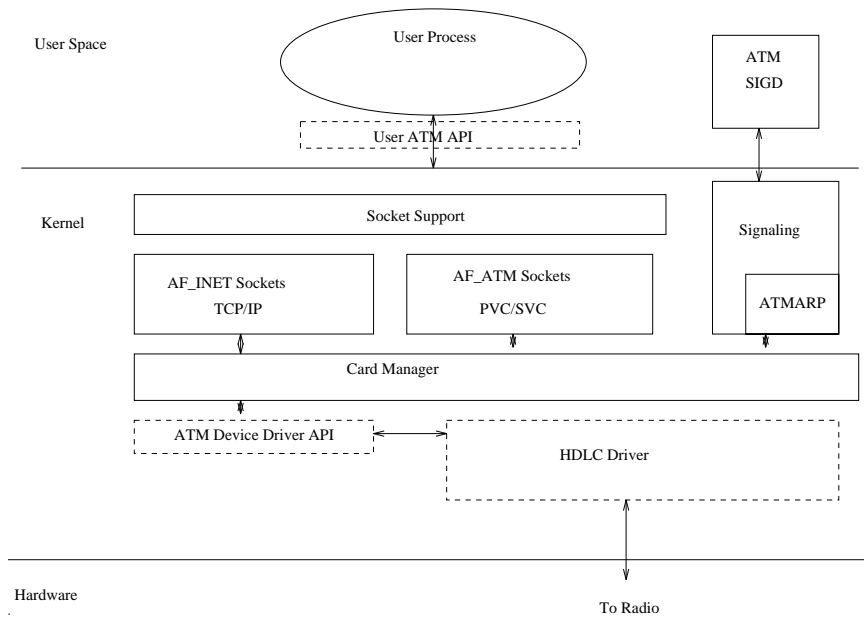

Figure 9: RN Linux ATM Protocol Stack.

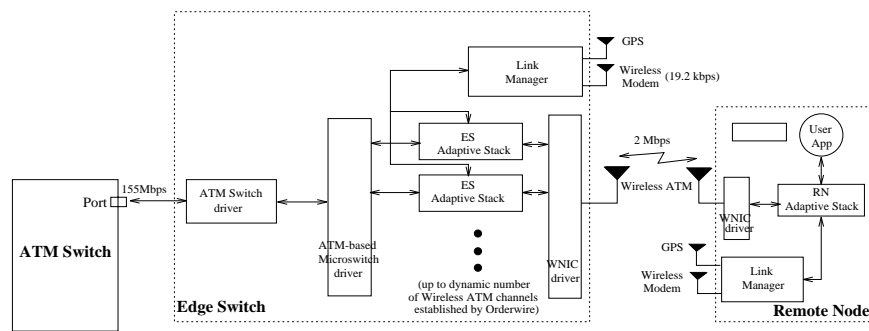

Figure 10: Detailed view of Edge Switch Connection to Remote Node.

4.1.2 Address Resolution

- Address resolution is considered in Section 5.

4.1.3 ATM Addressing

- Initially, E.164 addresses will be used. (optional)

4.1.4 ATM Adaptation Layer

- AAL-5 is the ATM Adaptation Layer to be used for IP. (mandatory)

4.2 Open Issues

- Resilient Virtual Circuits are a feature of the ATM switch which establishes point-to-point circuits between every pair of switch ports in the network where hosts could be attached. Will the ATM switch run in a LAN emulation mode with Resilient Virtual Circuits [5]?
- How will Q.2931 need to be modified in a mobile environment?
- How will ATM flow control be affected in a mobile environment ?

5 Network Layer

This section of the architecture is concerned with the Internet Protocol and how it relates to ATM and mobility. This layer provides a well known and widely used network layer, whose primary purpose is to provide routing between subnetworks and service for the TCP and UDP transport layers. The relation between IP and ATM is still an open issue. *Classical IP and ARP over ATM* [6] is an initial standards solution, however, it has several weak points such as requiring a router to connect Logical IP Subnetworks (LIS) even when they are directly connected at the ATM level, and requiring an ATM ARP server to provide address resolution for a single LIS. The *Non-Broadcast Multiple Access (NBMA) Next Hop Resolution Protocol (NHRP)*[7] provides a better solution, however it is still in draft form, and there may be better solutions, more amenable to a mobile environment, which are proposed before NHRP becomes a standard. Figure 11 shows the relationship of the IP standards in regard to the wireless link, fixed link, and address resolution on both links.

5.1 IP Layer Requirements

- IP must be able to reside on the ATM layer with reasonable performance and allow full interaction with “standard” IP and fixed networks. (mandatory)

- The IP level should be able to dynamically route packets. (mandatory)
- *Multiprotocol Encapsulation over ATM Adaptation Layer* [8] will be used. (mandatory)
- *Classical IP and ARP over ATM* will be used initially. (mandatory)
- An evolution towards NHRP will take place as the project progresses. (high priority)

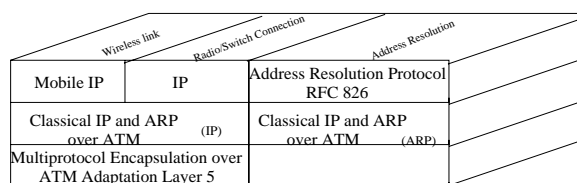

Figure 11: IP Layer Detail.

5.2 Open Issues

- Which of the IP over ATM models works best in a mobile environment?
- Which IP over ATM model appears to have more wide-spread usage?
- The existing timeout mechanism for ARP cache updates will be inadequate for mobile systems, particularly when ATM is used. Should an “UNATMARP” Extension be developed similar to UNARP [9] ?

6 Transport Layer

This section focuses on the effects of mobility on the transport layer. The scope of this section includes the effects of the transport layer in a mobile environment. The transport layer provides end-to-end connectivity. Note that the UDP/IP service allows dropped or unordered packets, while the TCP/IP service guarantees packet delivery. An open issue concerns whether TCP should be terminated at the EN on the fixed network side, allowing for a modified and more robust protocol across the wireless link. Initially, TCP/IP will not be terminated at the EN, but continue end-to-end.

Because of congestion control, current TCP implementations may suffer unacceptable delays during handoffs [1]. The handoff delay will cause the TCP window size to drop, a slow start algorithm will begin, and the retransmission timer will be set to a back-off interval that doubles with each consecutive timeout. The result is much larger drop in throughput and delay than simply

the time required to handoff. The Virtual Network Configuration algorithm, discussed in [10], provides a solution to this problem. Because the network configuration system runs ahead of real time, throughput should be as least as good as that shown for overlapping cells in [1].

A solution to help ease congestion of TCP/IP over ATM is given in [11]. TCP/IP headers are compressed using a differential method first developed by Van Jacobsen.

6.1 Transport Layer Requirements

- TCP/UDP will be used as the transport layer, although other transport protocols are not precluded. (mandatory)

6.2 Open Issues

- Should TCP be terminated at the fixed network side (e.g. “Snoop” [12]) algorithm, or end-to-end?

7 Link Quality

The link quality portion of the architecture actively maintains the quality of the mobile portion of the link. Figure 12 shows a high level control system view of the link. The scope of link quality in this section is limited to a static wireless network, i.e. no handoffs, although the feedback used in this system may indicate that QoS has degraded beyond the ability of the adaptive system to handle and a handoff is necessary. Section 10 covers this in more detail.

7.1 Link Quality Requirements

- Link quality should be monitored on a periodic basis. This can be either upon request or by exception, i.e. unsolicited notification based on preset values. (mandatory)

7.2 Assumptions

- There will be access to all required QoS measurements.

7.3 Open Issues

- Identify link QoS metrics
- Identify link metric measurement procedures
- Identify reaction to QoS information

Adaptive Protocols

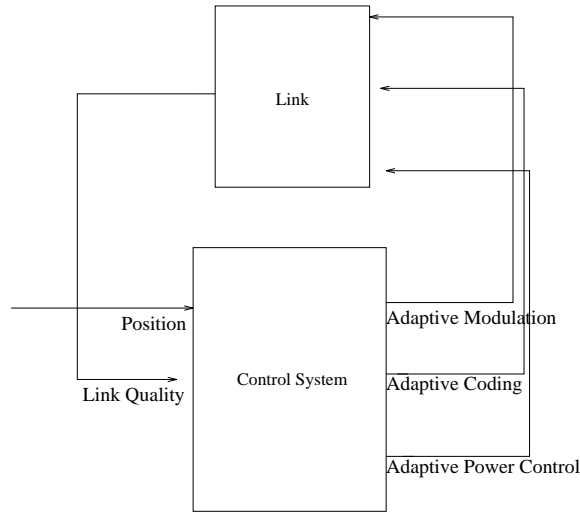

Figure 12: Adaptive Control.

- What QoS should determine when handoff takes place ?

8 Static Configuration

The scope of this section is limited to initial configuration of the wireless system in a static environment, i.e. no hand-offs take place. This is the primary difference between this section and Section 9. This includes the initial configuration at each level including: radio topology configuration, ATM switch configuration, and the standard protocol configuration, such as the HDLC-like and IP layers. The beamform process determines all possible topologies. Other parameters such as distance, load distribution, and signal power can be used to determine the best configuration.

There are two main levels of configuration which are required. At the lowest level, the RN radios must configure themselves to communicate with EN radios. Also, the ATM switches must learn the network topology in order to properly switch cells. The interaction between these two configuration tasks in a mobile environment is under study.

Each layer of the high speed radio connection will have a corresponding layer in the network configuration system, as shown in Table 1.

The following is a description and ordering of events for the establishment of the wireless connections.

Protocol Layer	Packet Types
Mobile-IP	MOBAGENT
IP (ATMARP InATMARP)	ARPSERVER
ATM	VC_SETUP
Radio Setup	USER_POS NEWSWITCH HANDOFF MYCALL SWITCHPOS TOPOLOGY

Table 1: Network Configuration System Layers.

MYCALL
Callsign
Start-Up-Time

Table 2: MYCALL Packet Contents.

NEWSWITCH

Table 3: NEWSWITCH Packet Contents.

SWITCHPOS
GPS time
GPS position

Table 4: SWITCHPOS Packet Contents.

TOPOLOGY
Number of Elements
Array of Callsigns and Positions of each element

Table 5: TOPOLOGY Packet Contents.

USER_POS
Callsign
GPS time
GPS position

Table 6: USER_POS Packet Contents.

At the physical level we will be using the orderwire to exchange position and link quality information and to setup the wireless connections. The process of setting up the wireless connections involves setting up links between edge nodes and between edge and remote nodes.

The network will have one master switch (EN), which will run the topology configuration algorithm [13] and distribute the resulting topology information to all the connected ENs over point-to-point packet radio links. The point-to-point link layer is AX.25 [14]. It provides automatic retries, and returns link errors to the orderwire.

The master EN could initially be the first active EN, and any EN would have the capability of playing the role of the master.

The first EN to become active would initially broadcast its callsign (where callsign = radio address) and start-up-time in a **MYCALL** packet (Table 2), and listen for responses from any other ENs. Since it is the first active EN, there would be no responses in a given time period, say T. At the end of T time, the EN could rebroadcast its **MYCALL** packet and wait another T seconds. At the end of 2T seconds, if there are still no responses from other ENs, the EN assumes that it is the first EN active and takes on the role of the master. If the first two or more ENs start up within T seconds of each other, at the end of the interval T, the EN could compare the start-up times in all the received **MYCALL** packets and the EN with the oldest start-up time would become the master.

Each successive EN that becomes active would initially broadcast its callsign in a **MYCALL** packet. The master on receipt of a **MYCALL** packet would extract the callsign of the source of the packet, establish a point-to-point link to the new EN and send it a **NEWSWITCH** packet (Table 3). The new EN on receipt of the **NEWSWITCH** packet over a point-to-point link, would obtain its position from its GPS receiver and send its position to the master as a **SWITCHPOS** packet (Table 4) over the point-to-point link. On receipt of a **SWITCHPOS** packet, the master would record the position of the new EN in its "switch position" table (table of EN positions), and run the topology configuration algorithm [13], to determine the best possible interconnection of all the ENs. The master would then distribute the resulting information to all the ENs in the form of a **TOPOLOGY** packet (Table 5) over the point-to-point links. The EN can then use this information to setup the high-speed links as specified by the topology algorithm. The master would also distribute a copy of

HANDOFF
Time Slot
Frequency
Phase

Table 7: HANDOFF Packet Contents.

its “switch position” table to all the ENs (over the point-to-point links), which they can use in configuring RNs as discussed below. This sequence of operations is illustrated in Figure 14 and Figure 15. Figure 16 and Figure 17 show the steps in configuring ENs and RNs respectively. Also, the EN can then use the callsign information in the “switch position” table to setup any additional point-to-point packet radio links (corresponding to the high-speed links) required to exchange any link quality information. Thus this scheme would result in point-to-point packet radio links from the master to every EN (a point-to-point star network with the master as the center of the star) and also between those ENs that have a corresponding high-speed link, as shown in Figure 13.

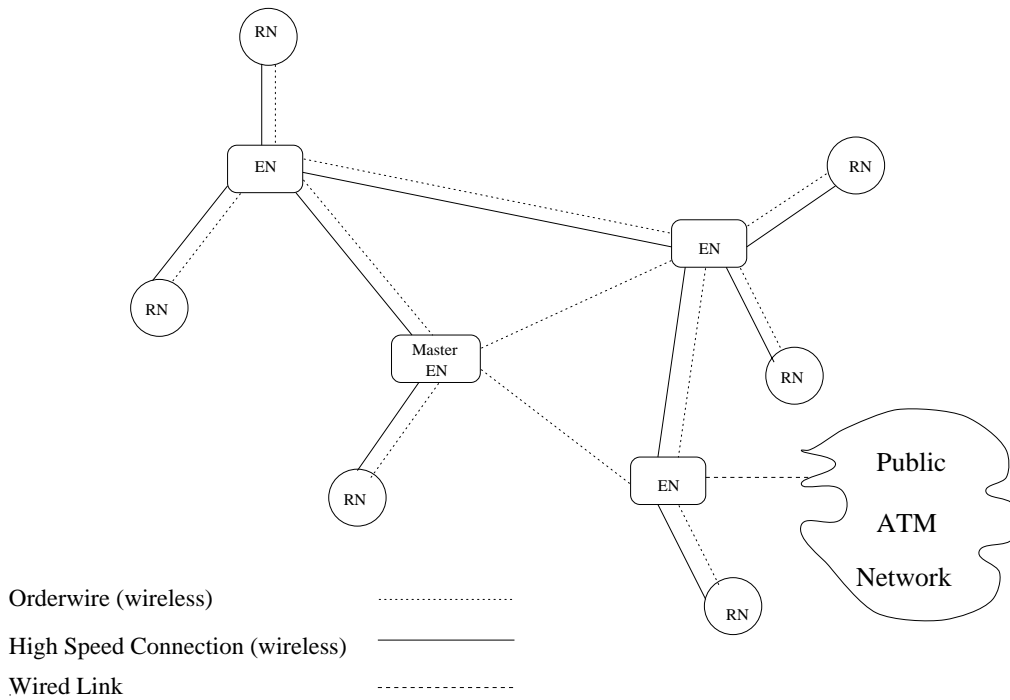

Figure 13: Example Orderwire Topology.

In the event of failure of the master node (which can be detected by listening for the AX-25 messages generated on node failure), the remaining ENs

VC_SETUP
IP Address
VCI

Table 8: VC_SETUP Packet Contents.

exchange **MYCALL** packets, elect a new master node, and the network of ENs is reconfigured using the topology configuration algorithm [13]. The efficiency of this method of handling failure of the master node versus maintaining a hot backup for the master node is to be studied.

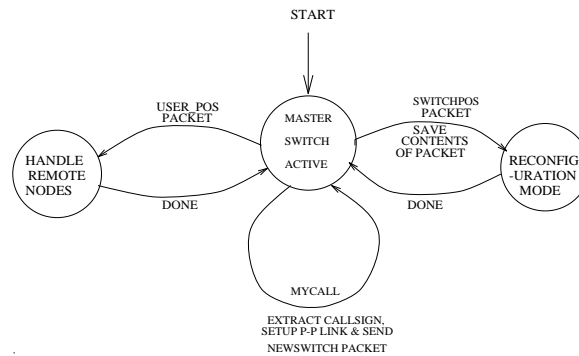

Figure 14: State Diagram for Master.

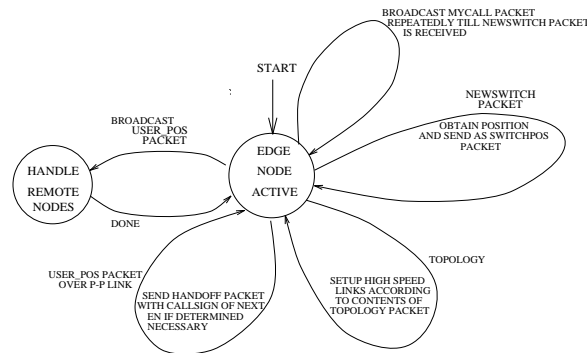

Figure 15: State Diagram for EN not serving as Master.

Each RN that becomes active would obtain its position from its GPS receiver and broadcast its position as a **USER_POS** packet (Table 6). This packet would be received by all the “nearby” ENs. Each candidate EN would then compute the distance between the RN and all the candidate ENs (which is

ARPSERVER
ATMARP Server Address

Table 9: ARPSERVER Packet Contents.

MOBAGENT
LIS Foreign Agent Address

Table 10: MOBAGENT Packet Contents.

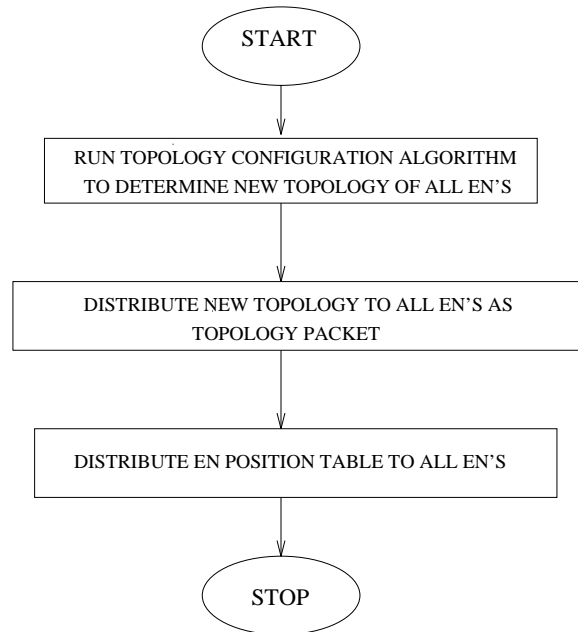

Figure 16: Flow Diagram for processes during Reconfiguration Mode State.

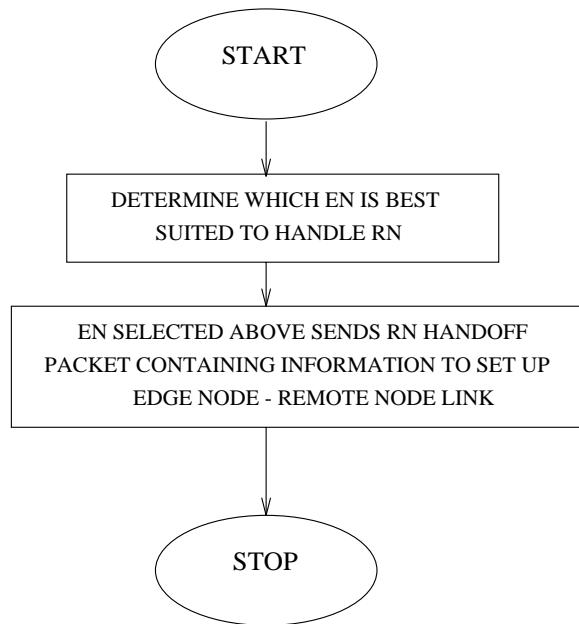

Figure 17: Flow Diagram for processes during Handle RN State.

possible since each EN has the positions of all the other ENs from the “switch position” table). An initial guess at the best EN to handle the RN would be the closest EN. This EN would then feed the new RN’s position information along with the positions of all its other connected RNs to a beamsteering algorithm that returns the steering angles for each of the beams on the EN so that all the RNs could be configured. If a time slot and/or beam is available to fit in the new RN (this information will be returned by the beamforming algorithm), the EN would steer its beams so that all its connected RNs and the new RN are configured, record the new RN’s position in its “user position” table (table of positions of connected users), establish a point-to-point link to the new RN and send it a **HANDOFF** packet (Table 7) with link setup information indicating that the RN is connected to it. If the new RN cannot be accommodated, the EN would send it a **HANDOFF** packet with the callsign of the next closest EN, to which the RN could send another **USER_POS** packet over a point-to-point link. This EN could then use the beamform algorithm to determine if it could handle the RN, and so on. Figure 18 shows the states of operation and transitions between the states for a RN.

This scheme thus uses feedback from the beamforming algorithm together with the distance information to configure the RN. It should be noted that the underlying AX.25 protocol [14] ensures error free transmissions over point-to-point links. Also the point-to-point link can be established from either end and

the handshake mechanism for setting up such a link is handled by AX.25. If the RN does not receive a **HANDOFF** packet within a given time it can use a retry mechanism to ensure successful broadcast of its **USER_POS** packet.

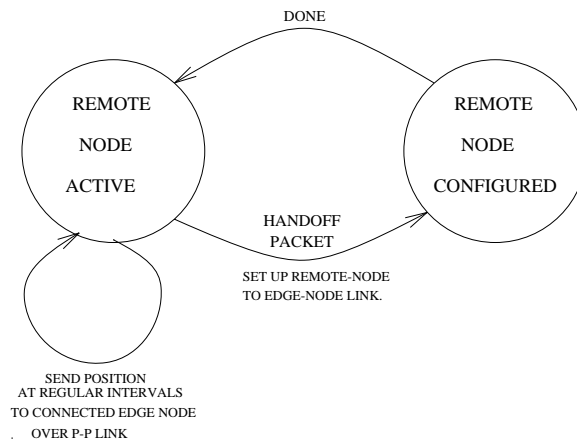

Figure 18: State Diagram for RN.

8.1 Establishing an End-to-End Connection

The following sections describe the operation of the network configuration system in establishing ATM connections.

8.1.1 ATM Network Configuration Layer

This section describes virtual circuit setup by the network configuration system. There are two approaches at this level, depending on whether switched virtual circuits (SVCs) or Permanent Virtual Circuits (PVCs) are available. RFC1577 [6] is followed on both the fixed and wireless networks. A Logical IP Subnet (LIS) can be comprised of fixed and wireless portions of the network.

As a requirement for RFC1577 the underlying virtual fiber connections must be fully meshed. If switched virtual circuits are not available, the network configuration program, of which the orderwire is a part, will immediately establish a fully meshed VC configuration. In order to establish this fully meshed network, the network configuration system must have knowledge of all nodes to be connected. All wireless nodes are clearly available from the physical setup layer, however, the nodes which reside on the fixed network are not known. Information about which nodes reside on the fixed network can come from the ATMARP server.

The network configuration system establishes the fully meshed VC connections as follows. The EN on receipt of a **USER_POS** packet (Table 6) from

a new physically connected RN sends pairs of **VC_SETUP** packets (Table 8) to the new RN and each one of the existing RNs. Each **VC_SETUP** packet contains a designated IP address of the new RN and a VCI number identifying the VC to be setup. The RN on receipt of each pair of **VC_SETUP** packets, extracts the IP address and VCI number from each **VC_SETUP** packet and uses it to setup the VC. Since the **VC_SETUP** packets are sent in pairs to the new RN and to each of the existing RNs for each RN in the network, VCs will be setup between the new RN and each of the existing RNs resulting in a fully meshed VC configuration as desired.

If switched virtual circuits are used, only the signaling VCs as specified in the standards will be established in a manner similar to that described above.

In the prototype system, remote nodes tear down their VCs and re-establish connections when handing off from one switch to another. The time to establish a PVC from the network configuration system has been measured to be on the order of 300 milliseconds. This includes the time to send a PVC setup message to the switch from the network configuration processor, until an acknowledgment is received at the network configuration processor.

8.1.2 ARP Network Configuration Layer

This section discusses how the network configuration system helps solve the problem of address resolution.

If PVCs are used, only InATMARP [15], is required. The receiving side of an InATMARP packet will infer the IP address from the packet, and the sender will receive a InATMARP response. Thus both sides will be able to complete their ARP tables.

If SVCs are used, the operation is more complex. After the **HANDOFF** packet has been sent to the RN, an **ARPSERVER** packet (Table 9) is sent. This packet contains the ATM address of the ATMARP server. Thus the RN will be able to register with the ATMARP server, [6], by initiating a connection to the ATMARP server. The ATMARP server will respond with an InATMARP request which will update both ARP tables. Next, the ATMARP server will respond to the ATMARP request with a reply if it has an entry for the requested IP address. If there is no such address in its table, it responds with an ATM_NAK. If the reply is successful, the remote node will have the ATM address for a given IP address.

8.1.3 Mobile-IP Network Configuration Layer

This section describes how Mobile-IP benefits from the network configuration system.

The network configuration system, after sending the **ARPSERVER** packet, will transmit a **MOBAGENT** packet (Table 10). This packet will contain the address(es) of mobile IP agents for this Logical IP Subnet (LIS). The RN needs

to determine whether it is on the same network as its home agent. Each RN will have preconfigured its home-address, routing prefix size, and one or more home agents, as described in [16]. Thus, the RN will know whether it is at home, or requires a foreign agent. Agents will broadcast ICMP router discovery messages with IP mobility extensions, in addition to being identified by the **MOBAGENT** packet, as described in [16].

If the RN is not at home, then it will register with its Mobile-IP home agent using UDP to send a Registration Request. It will do this by first choosing a foreign agent, and sending the message to the foreign agent, which relays the message to the home agent. The home agent responds with either a successful reply or an error code. If successful, the home agent may send a gratuitous proxy [ATM]ARP on behalf of the mobile node, and will forward and encapsulate IP traffic to the foreign agent. The foreign agent will de-encapsulate the IP packets and forward them to the remote node.

8.2 Configuration Requirements

- The radio links should be automatically configured and connected upon startup. (mandatory)
- The ATM switch should be able to automatically determine the topology. (mandatory)
- Users should be connected with the switch which provides the best QoS. (mandatory)
- Configuration should not take an excessive amount of time. (mandatory)

8.3 Open Issues

- The radio topology and frequency assignment algorithm [13] currently takes on the order of several minutes to complete. It must be run each time the EN to EN topology changes. This requires that ENs remain fixed. Virtual Network Configuration [17] can be used once the system is in operation. Should the orderwire configuration processing be distributed rather than redundantly computed at each node in order to speedup this operation ?
- How will QoS be defined and used to guide the topology ?
- Depends on a master configuration node: how can it be made more reliable, e.g. hot backup or redo the entire topology ?
- This algorithm assumes all packet radios are within broadcast range of each other. What problems may occur if the network grows large enough that some packet radio nodes cannot reach others ?

9 Reconfiguration

Reconfiguration is the first section in this document which deals with a dynamic environment, i.e. Remote Nodes are allowed to move from Edge Node to Edge Node or a link may become inoperable. There are four levels of reconfiguration: physical, link level, ATM [18], and IP [16].

9.0.1 Physical Level

The point-to-point orderwire links described in Section 8 would be retained as long as a RN is connected to a particular ES and a corresponding high-speed link exists between them to enable exchange of link quality information. The link can be torn down when the mobile RN migrates to another ES in case of a handoff. Reconfiguration occurs as described in Section 8.

9.0.2 Link Level

A protocol similar to HDLC-like is being used as the link layer. See Section 7 for details about this layer. Handoff at this layer is considered in Section 10.

9.0.3 ATM Level

The ATM configuration algorithm is based on configuration in AutoNet [18] and is comprised of two phases, monitoring and topology acquisition. The monitoring algorithm watches links for changes in up/down status. It incorporates a mechanism for damping oscillations between states which may be even more useful for a radio environment than for the fixed network environment for which it was designed. The topology acquisition phase propagates neighborhood information from each switch to a root node, which then distributes the result back to all nodes. A mechanism is included to handle recurrent topology changes. The latest change is given priority, thus earlier propagation phases die out, before the latest one ends.

9.0.4 Network Level

Reconfiguration for Mobile IP is defined in [16] and occurs as described in Section 8. Mobile IP [16] supports mobile routers and LANs as well as hosts.

9.1 Reconfiguration Requirements

- The network must automatically handle changes in network configuration (including handoffs) without impacting performance. (mandatory)
- The rate of position updates will vary in proportion to the speed of the mobile unit. (mandatory)

- The radio topology algorithm [13] takes on the order of minutes to complete execution. Unless the algorithm is speeded up significantly, RNs must not be required to run the algorithm for more than an initial configuration. (mandatory)

9.2 Open Issues

- Will the skeptic portion of the Autonet [18] algorithm be required to dampen oscillations? This maintains the stability of the network so that reconfiguration is not required as often.
- How do the physical, link level, and ATM configuration processes interact?
- Is incremental reconfiguration necessary for the RNs and how should it be implemented?
- How much speedup will VNC [17] provide to network reconfiguration ?

10 Handoff

This section focuses on the actual mechanism for implementing handoff of a host from one switch to another at each layer. This will affect ATM cell ordering, routing, and signaling.

An attempt to solve this leads to the development of Virtual Network Configuration (VNC). VNC is an algorithm for quickly and dynamically configuring the RDRN network. The primary benefit is rapid configuration of all mobile network layers based on predicted location by caching results ahead of time.

10.1 Handoff Requirements

- Soft handoff should be used. (optional)
- Dynamic VCI changes to switch tables should be allowed. (high priority)
- ATM cells must be delivered in order. (mandatory)
- Hand-offs should be anticipated. (mandatory)

10.2 Open Issues

- Resource reservation and RSVP routing in a mobile environment [19], [20].

10.2.1 Link Layer

- How should the link layer protocol be optimized for handoffs ?

10.2.2 ATM Layer

- How should handoff take place [21]. Should a VCI tree structure be used as in [22] ?
- How will cell order be maintained?

10.2.3 IP Layer

- Can the handoff mechanism in Mobile IP be improved [23] ?

10.2.4 Network Configuration Protocol Layer

- What increase in performance will be gained by use of Virtual Network Configuration [17] ?

11 Summary

A specification for the network architecture and functionality of the Rapid Deployment Radio Network is provided. Each protocol layer, as well as configuration, reconfiguration, link quality, and mobility are discussed. Open issues in each of the above areas are defined.

References

- [1] Ramon Caceres and Liviu Iftode. Improving the Performance of Reliable Transport Protocols in Mobile Computing Environments. *IEEE Journal on Selected Areas in Communications*, 13(5), June 1995.
- [2] Werner Almesberger. *Linux ATM*, December 1995. Web Page URL: <http://lrcwww.epfl.vh/linux-atm/>.
- [3] IETF. *ATM Signaling Support for IP over ATM*, 1995. Online version available at <gopher://ds.internic.net/00/internet-drafts/draft-ietf-atm-sig-00.txt>.
- [4] CCITT. *Q.2931*, 1995. Online version available at <gopher://cell-relay.indiana.edu/11/docs/current/CCITT/Q.2931>.
- [5] TISL. *MAGIC Project*, 1995. Online version available at <http://hopper.tisl.ukans.edu/MAGIC/private/an2/>.
- [6] IETF. *Classical IP and ARP over ATM*, 1995. Online version available at <http://ds.internic.net/rfc/rfc1577.txt>.

- [7] Routing over Large Clouds Working Group. *NBMA Next Hop Resolution Protocol (NHRP)*, 1995. Online version available at [gopher://ds.internic.net/00/internet-drafts/draft-ietf-rolc-nhrp-04.txt](http://ds.internic.net/00/internet-drafts/draft-ietf-rolc-nhrp-04.txt).
- [8] IETF. *Multiprotocol Encapsulation over ATM Adaptation Layer 5*, 1995. Online version available at <http://ds.internic.net/rfc/rfc1483.txt>.
- [9] Xylogics. *ARP Extension - UNARP*, 1995. Online version available at [gopher://ds.internic.net/00/internet-drafts/draft-malkin-unarp-01.txt](http://ds.internic.net/00/internet-drafts/draft-malkin-unarp-01.txt).
- [10] Stephen F. Bush, Sunil Jagannath, Joseph B. Evans, and Victor Frost. A Control and Management Network for Wireless ATM Systems. In *Proceedings of the International Communications Conference '96*, pages 459,463, June 1996. Conference web page <http://www-ee.uta.edu/organizations/-commsoc/commsoft.html>.
- [11] Brian Buchanan. TCP/IP Header Compression for High-Speed ATM Links. Master's thesis, Telecommunications and Information Science Laboratory University of Kansas, September 1995.
- [12] E. Amir, H. Balakrishnan, S. Seshan, and R. Katz. Efficient TCP over Networks with Wireless Links. In *Proceedings HotOS-V Workshop, Orcus Island, WA*, May 1995.
- [13] Shane Haas. A Consistent Labeling Algorithm for the Frequency/Code Assignment in a Rapidly Deployable Radio Network (RDRN). Technical Report TISL-10920-04, Telecommunications & Information Sciences Laboratory, Jan 1995.
- [14] IEEE. *AX.25 Amateur Packet Radio Link-Layer Protocol*, October 1984.
- [15] T. Bradely and C. Brown, editors. *Inverse Address Resolution Protocol*. Wellfleet Communications, January 1992. Online version available at <http://ds.internic.net/rfc/rfc1293.txt>.
- [16] C. Perkins, editor. *IP Mobility Support*. Mobile-IP Working Group, October 1996. Online version available at <http://ds.internic.net/rfc/rfc2002.txt>.
- [17] Stephen F. Bush. Proposal for the Design and Analysis of Virtual Network Configuration for a Wireless Mobile ATM Network. Thesis Proposal.
- [18] Thomas L. Rodeheffer and Michael D. Schroeder. Automatic Reconfiguration in Autonet. In *Proceedings of the 13th ACM Symposium on Operating System Principles*, pages 183–187, 1991.
- [19] Bellcore. *Integration of Real-time Services in an IP-ATM Architecture*, 1995. Online version available at [gopher://ds.internic.net/rfc/rfc1821.txt](http://ds.internic.net/rfc/rfc1821.txt).

- [20] Stephen F. Bush, Joseph B. Evans, and Victor Frost. Mobile ATM Buffer Capacity Analysis. *ACM-Baltzer Mobile Networks and Nomadic Applications (NOMAD)*, 1(1), February 1996. Web Page URL: <http://www.tisl.ukans.edu/~sbush>.
- [21] K. Y. Eng, M. J. Karol, M. Veeraraghavan, E. Ayanoglu, C. B. Woodworth, P. Pancha, and R. A. Valenzuela. BAHAMA: A Broadband Ad-Hoc Wireless ATM Local-Area Network. In *Proceedings of ICC'95*, pages 1216,1223, February 1995.
- [22] Anthony S. Acampora and Mahmoud Naghshineh. An Architecture and Methodology for Mobile-Executed Handoff in Cellular ATM Networks. *IEEE Journal of Selected Areas in Communication*, 12(8), October 1994.
- [23] Srinivasan Seshan, Hari Balakrishnan, and Randy H. Katz. Handoffs in Cellular Wireless Networks: The Daedalus Implementation Experience. *Kluwer International Journal on Wireless Personal Communications*, 1996.