

The University of Kansas



**Information and
Telecommunication
Technology Center**

Technical Report

The Effect of Soft Handoff on the User Capacity of CDMA PCS with Multiple Classes of Users

Helen Chen and James A. Roberts

ITTC-FY2000-TR-11880-02

July 1999

Sprint Corporation
Long Distance Division
Technology Planning and Integration

Copyright © 1999:
The University of Kansas Center for Research, Inc.,
2291 Irving Hill Road, Lawrence, KS 66044-7541;
and Sprint Corporation.
All rights reserved.

ABSTRACT

Current cellular technology is driven by the need to provide a better quality of service (QoS) and to accommodate an increased number of users. An essential component of mobile cellular communication systems which greatly affects system capacity is the handoff process which occurs when a mobile communicates from one base station to another. From the first-generation cellular systems, such as the Advanced Mobile Phone System (AMPS), through the second-generation cellular systems, the Global System for Mobile Communications (GSM), handoff techniques developed from a simple structure to specific handoff algorithms. Now, in the third-generation cellular systems, IS-95 code-division multiple access (CDMA), a "soft handoff" technique is proposed to further increase the capacity.

Unlike traditional frequency division multiple access (FDMA) and time division multiple access (TDMA), in which each user occupies different frequency spectrum or time slot in order to transmit data, in CDMA systems every user occupies the same spectrum. Different orthogonal codes are assigned to the users in order to separate them from each other, but interference can still be introduced in this system. Compared to other handoff techniques used in CDMA system, e.g. hard handoff, soft handoff has two well-known advantages: extending CDMA cell coverage and increasing reverse link capacity of the system.

This report presents an overview of soft handoff. The benefits and disadvantages of using soft handoff in CDMA systems over traditional hard handoff are discussed. Based on one class of users (the voice user), Viterbi and Gilhausen et al have studied CDMA capacity. Their studies are extended in this report to quantify the effect of soft handoff on extending cell coverage and increasing reverse link capacity under the assumption of perfect power control. Our studied emphasize the effect of variations in soft handoff area on CDMA capacity. Further, this analysis is expanded to include a homogeneous set of users defined by their bandwidths and fidelity requirements. CDMA capacity with mixed classes of users was evaluated in [3]. In this report, we extend their results to compare CDMA capacity with soft and hard handoff. CDMA capacity is also studied with a homogenous set of users, under variations in soft handoff area. The conclusions drawn from this work are summarized and some suggestions for future work are provided.

TABLE OF CONTENTS

Chapter 1	Introduction	1
	1.1 Background	1
	1.2 Motivation	2
	1.3 Organization of the report	3
Chapter 2	Soft Handoff and Hard Handoff	5
	2.1 Concepts of Soft Handoff and Hard Handoff	5
	2.2 Power and Soft Handoff	7
	2.3 Advantages and Disadvantages of Soft Handoff	8
	2.3.1 Advantages of Soft Handoff	8
	2.3.2 Disadvantages of Soft Handoff	9
Chapter 3	Reverse Link Capacity Analysis for One Class of Users with Hard Handoff and Soft Handoff	10
	3.1 Propagation Model	10
	3.2 Reverse Link Capacity Analysis	12
	3.2.1 Reverse Link Capacity with Hard Handoff	13
	3.2.2 Reverse Link Capacity with Soft Handoff	17
	3.2.2.1 Other-cell Interference Factor	18
	3.2.2.2 Reverse Link Capacity with Soft Handoff	22
	3.2.3 Reverse Link Capacity Validation Test	23
	3.2.3.1 Viterbi's Reverse Link Erlang Capacity	24
	3.2.3.2 Validation Test	27
	3.3 Soft Handoff Median Range Effect on Reverse Link Capacity	32
	3.3.1 Other-cell Interference Factor	32
	3.3.1.1 Hard Handoff Other-cell Interference Factor	32
	3.3.1.2 100% Soft Handoff Other-cell Interference Factor	35
	3.3.2 Soft Handoff Median Range Effect on Reverse Link Capacity	39
Chapter 4	Reverse Link Capacity Analysis for Multiple Classes of Users	45
	4.1 Propagation Model	45
	4.2 CDMA Capacity for Multiple Classes of Users	46
	4.2.1 CDMA Capacity for One Class of Users	46
	4.2.2 CDMA Capacity for More than One Class of Users	47
	4.3 Handoff Effect on CDMA Capacity for Multiple Classes of Users	50
	4.3.1 CDMA Capacity Comparison with Hard and Soft Handoff for Multiple Classes of Users	51

	4.3.1.1 Effect of BER Requirements on CDMA Capacity for Multiple Classes of Users	51
	4.3.1.2 Effect of User Data Rate on CDMA Capacity for Multiple Classes of Users	56
	4.3.1.3 User Activity Factor Effect on CDMA Capacity for Multiple Classes of User	59
	4.3.2 Soft Handoff Region Effect on CDMA Capacity	62
Chapter 5	Conclusions and Future Work	65
	5.1 Summary of Results	65
	5.2 Suggestions for Future Work	66
	Bibliography	68

Chapter 1 Introduction

1.1 Background

Cellular systems must serve multiple simultaneous users without experiencing excessive interference. In order to accomplish this, service providers may use one of three primary multiple access schemes: frequency division multiple access (FDMA), time division multiple access (TDMA) and code division multiple access (CDMA).

FDMA is a multiple access method in which users are assigned specific frequency bands. In TDMA, users share an assigned frequency band, but each user is allowed to transmit in predetermined time slots.

CDMA is a method in which users share time and frequency allocations. The users are distinguished from each other by uniquely assigned codes. The signals are separated at the receiver by using a correlator that accepts only signal energy from the desired channel. Undesired signals contribute to the noise.

CDMA is an enabling digital technology that may greatly increase system capacity over other multiple access schemes. For example, IS-95 CDMA has a claimed capacity of 10 times that of the Advanced Mobile Phone System (AMPS), and three times that of the capacity of TDMA [2]. Also, IS-95 CDMA may offer greater coverage than competing multiple access systems. Under the demand of higher capacity and better quality of service (QoS) of cellular systems, CDMA has become a promising technology.

Handoff is an integral part of mobile communications systems. A handoff occurs when the servicing base station changes as the mobile moves between cells. In first-generation cellular systems, such as AMPS, handoffs are relatively simple. In second-generation cellular systems, such as the Global System for Mobile Communications (GSM), improved handoff algorithms are used which employ mobile-assisted handoffs (MAHO) or mobile-controlled handoffs (MCHO) control/decision structure. In third-generation IS-95 CDMA cellular systems, a more advanced handoff ("soft" handoff) system which allows communications from the mobile to multiple base stations simultaneously is implemented. The concepts of soft and hard handoff and the differences between them will be discussed in detail in Chapter 2.

1.2 Motivation

The popularity of digital mobile service has led to a rapid increase in the number of subscribers. This in turn has led to research into the development of new technologies to increase the capacity of the entire system. CDMA is one method that has been proposed to meet such requirements [2]. CDMA is an interference-limited multiple access technique. A mobile that is being served by one base station when there is less path loss

to another base station will be transmitting more power than is necessary. The fact that the mobile, and all others like it, radiates excess power raises the overall interference level. The higher the overall interference level, the less the total capacity. Soft handoff is an IS-95 CDMA technique which minimizes mobile transmit power and reduces system interference [4].

With traditional hard handoff, the mobile is served by only one base station at any time. In order to switch base stations when the mobile moves from one base station to another, first the connection to the current base station is broken, then the connection to the new base station is made. This process introduces "decision" delay and "switch" delay. In order to prevent the mobile from being handed back and forth, excessively in areas served by more than one base station, a hysteresis is required in hard handoff process. The extra delays and hysteresis increase the signal level, therefore introducing more interference [9]. On the other hand, since all base stations in CDMA use the same frequency band, it is possible for mobiles to connect to the new base station first before leaving the current one (soft handoff). Thus, the handoff delay is reduced and the hysteresis is not needed. In this report, soft handoff CDMA capacity will be shown to be greatly increased compared to that of hard handoff. Also, when soft handoff area (the area where mobiles are in soft handoff) is varied, CDMA capacity will change accordingly. This effect will be taken into account in this report and the maximum capacity will be found with soft handoff.

Furthermore, since third-generation wireless networks are required to accommodate a diverse set of information sources (e.g. voice, data and video), CDMA capacity with multiple classes of users is also studied in this report and the results using hard and soft handoff are compared. When the soft handoff area is changing, CDMA capacity is evaluated with multiple classes of users.

1.3 Organization of the report

This report is organized as follows. In Chapter 2, the concept of hard and soft handoff will be introduced in more detail. The advantages and disadvantages of these two handoff techniques are discussed and compared. In Chapter 3, under the assumption that only one class of user present in the system, CDMA capacity with soft handoff and hard handoff will be analyzed and compared numerically, based on the results from Viterbi and Gilhousen et al. Furthermore, with the change of soft handoff area, the corresponding CDMA capacity will be estimated. In Chapter 4, we exploit results in [3] to evaluate CDMA capacity with multiple classes of users. Also, as soft handoff area is varied the capacity for every class of user is calculated. The conclusions and suggestions for future work are provided in Chapter 5.

Chapter 2

Soft Handoff and Hard Handoff

Handoff is an important component of mobile cellular communication systems. Two kinds of handoff techniques may be used in CDMA systems--the traditional hard handoff and the soft handoff technique, introduced by [2]. In this chapter, an overall view of hard handoff and soft handoff is provided.

2.1. Concepts of Soft Handoff and Hard Handoff

As a mobile moves from one cell towards another, the power of the received pilot signal from the initial serving base station decreases as the mobile moves away, and the power of the pilot signal received from the second base station increases as the mobile moves towards that base station. "Handoff" occurs when the mobile service is transferred from the initial base station to the second one.

During the hard handoff process, the connection to the current base-station has to be broken before the connection to the new base station is made. This is called "break-before-make" handoff. The decision to handoff is made when the pilot signal from the second base station is considerably stronger than that of the first base station. Hysteresis is introduced in the handoff process to prevent the so-called "Ping-Pong" effect in which the mobile is handed back and forth several times from one base station to the other during handoff. The hysteresis parameter normally requires that the pilot signal from the second base station be somewhat higher than that of the initial base station before handoff occurs. This process is illustrated in Figure 2-1. When the mobile moves from base station A to base station B, the pilot signal from base-station A drops as the mobile moves away and the pilot signal from base station B increases. Without hysteresis, the hard handoff is performed at point "a" where the pilot signals from the two base stations are equal. This could lead to a "Ping-Pong" effect as the relative strength of the two pilot signals varies over the handoff area. With hysteresis the handoff is performed at point "b" where the pilot signal from base station B is considerably stronger than that of base station A, reducing the likelihood of a handoff back to base station A.

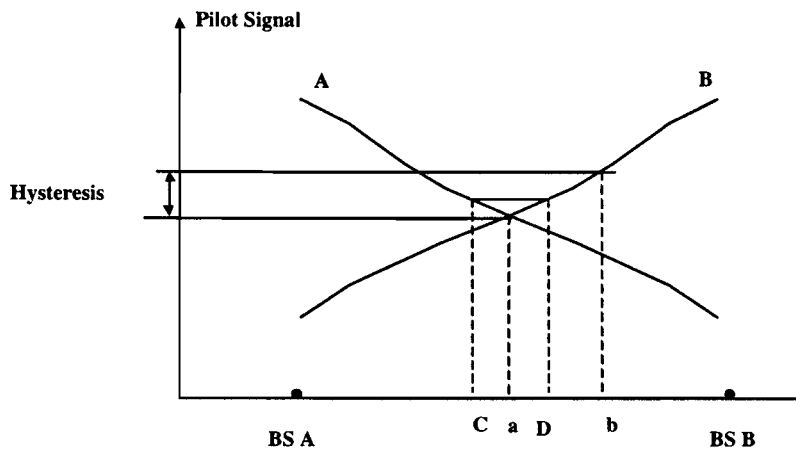

Fig 2-1. The Illustration of the Mobile's Pilot Signal from Base Stations

In soft handoff, the mobile is connected to two or more base stations simultaneously when the pilot signal level of each is of similar strength. When one pilot signal weakens below a specified threshold, a hard decision to drop that base station is made. This soft handoff process is called "make-before-break."

As shown in Figure 2-1, in soft handoff from points "C to "D the mobile is communicating with base stations A and B at the same time. After point "D" the mobile only communicates with base station B.

Because hard handoff is a "break-before-make" process requiring hysteresis, higher transmit signal power is needed than for the soft handoff technique. Thus, more interference is introduced into the system and the capacity is reduced. On the other hand, in soft handoff the hysteresis is not needed. Therefore, the required signal power is lower than that in hard handoff case, and the total interference is reduced. This results in greater capacity.

2.2. Power Control and Soft Handoff

CDMA is an interference-limited system in which the users are ideally separated by different orthogonal codes. In a real world deployment, a strong interfering signal may mask out a weak desired signal, causing unreliable detection of the latter. This is called the "near-far" problem. For a reasonable level of performance, mobile power-control is necessary in order that the multiple orthogonal signals arrive at the base station at approximately the same receive level.

A CDMA system with power-control dynamically adjusts transmitter powers while in operation. In order to make the power control work properly,

the user should be linked at all times to the base station from which the user receives the strongest signal. Because of the nature of soft handoff, the user is indeed linked at all times to the base station that can offer the user the highest pilot signal. Hard handoff can not guarantee this.

2.3 Advantages and Disadvantages of Soft Handoff

2.3.1 Advantages of Soft Handoff

- Soft handoff provides better voice quality

As we mentioned before, soft handoffs reduce the "Ping-Pong" effect common in hard handoff. This results in more seamless user communications devoid of the "clicks" typical of hard handoff which are caused when speech transmissions are stopped momentarily during handoffs.

- Soft handoff increases cell coverage and CDMA capacity

With soft handoff, a user can always communicate with the best base station and hysteresis is not needed (as mentioned in 2.1). This results in less delay and less interference in the system. For a fixed cell size and fixed transmit powers, the overall interference is reduced, leading to an increase in the capacity. (Notice it is generally believed that the reverse link is the limited link in a CDMA system [4]. "Capacity" in this report will refer to the reverse link capacity.) If the outage probability (the probability that a user's quality of service threshold can not be met) and transmitted power are fixed, soft handoff will increase cell coverage.

- Soft handoff reduces the blocking probability and the probability of dropped calls

With soft handoff, the addition of weaker neighboring cells prior to the loss of a once dominant serving cell reduces the delay and queueing time associated with the hard handoff process. This helps reduce the blocking probability and the probability of dropped calls.

2.3.2 Disadvantages of Soft Handoff

- Soft handoff is more complex than hard handoff, and therefore more expensive to implement.
- Forward link interference increases when soft handoff is in progress since several base stations are transmitting what would otherwise be transmitted by one base station. Typically, the interference increase is slight. The critical link is the reverse link.

Above we have given an overall comparison of soft handoff and hard handoff. But it is still difficult to conclude which type of handoff is better in absolute terms. In the next chapter, we will numerically compare the CDMA capacity in terms of number of users per cell using soft and hard handoff.

Chapter 3 Reverse Link Capacity Analysis for One Class of Users with Hard Handoff and Soft Handoff

For cellular CDMA systems, an important measurement of economic usefulness is the maximum number of users that can be served simultaneously, i.e. the capacity. Viterbi et al [4] have analyzed CDMA Erlang capacity with hard handoff and calculated hard handoff and 100% soft handoff other-cell interference factors. Gilhousen has derived CDMA capacity in terms of number of users per cell with hard handoff [1]. In this chapter we will extend their analyses and demonstrate that soft handoff has greater reverse link capacity in terms of number of users per sector than hard handoff. (Reverse link capacity is assumed to be the limiting factor in determining system capacity.) We also calculate CDMA capacity under variations in soft handoff area.

3.1 Propagation Model

The propagation attenuation is modeled as the product of the n^{th} power of distance and a lognormal component representing shadowing losses. For a user at a distance r from a base station, attenuation $l(r)$ is given by

$$l(r) = r^n 10^{\zeta/10} \quad (3-1)$$

where ζ is the dB attenuation due to shadowing, with zero mean and standard deviation σ . The losses in dB are

$$L(r) = 10n \log r + \zeta \quad (3-2)$$

Experimental data from mobile propagation testing [4] shows $n=4$ and $\sigma=8\text{dB}$ to be typical values for the parameters in many environments.

Local changes in terrain and morphology near a mobile user and near surrounding base stations will affect the reverse signal variations as the mobile moves. Because of the relatively large separation distance of the surrounding base stations, the reverse link level variations caused by local conditions at the base stations can be considered to be independent; however, the local propagation affecting conditions near the mobile will sometimes influence multiple reverse paths simultaneously, causing some correlation in reverse link levels. The random component of the dB loss γ is expressed as the sum of two factors above and is defined as [4]:

$$\gamma_i = a\xi + b\xi_i \quad (3-3)$$

where ξ represents the variation around the mobile, which is common to all base stations, ξ_i represents the variation around the base station i , which is independent from one base station to another. ξ and ξ_i are assumed to be independent identically distributed random variables with zero mean and a standard derivation of σ . a and b are the standard deviations of the near field and base station specific propagation uncertainties. Also, $a^2 + b^2 = 1$. The normalized correlation is

$$E\left(\frac{\gamma_i \gamma_j}{\sigma}\right) = a^2, \quad (3-4)$$

for all $i \neq j$.

A reasonable assumption is that the near field and base station specific propagation uncertainties have equal standard deviations, in which case $a^2 = b^2 = 1/2$. We use this assumption throughout this report.

Further, assuming that there are three sectors per cell with uniform density of subscribers and normalizing the hexagonal cell radius to unity, the average number of subscribers per cell N_c is $3N_s$, where N_s is the number of subscribers per sector. The density of users is then given by [4]

3.2 Reverse Link Capacity Analysis

$$\rho = \frac{2N_c}{3\sqrt{3}} = \frac{2N_s}{\sqrt{3}} \quad (3-5)$$

In conventional cellular systems like TDMA and AMPS, the capacity in terms of maximum number of users per cell is a “hard limit,” given by the total possible number of frequency slots or time slots available to the users. When all the slots are occupied, blocking will occur for any additional access attempts.

The acceptable performance for voice users should be their bit error rate (BER) less than 10^{-3} . In a CDMA system this requirement will be obtained for a service fraction P (e.g. $P=0.99$) [1]. The fraction for which adequate performance will not be achieved is called the outage probability (e.g. $P_{out}=1-0.99=0.01$). When the number of users increases, the overall performance degrades, resulting in an increase in the outage probability. Therefore, the capacity in a CDMA system is a “soft limit” set by the outage probability. In CDMA, different handoff schemes affect the outage probability, thus influencing capacity. In this section, CDMA reverse link capacity with hard and soft handoff is evaluated.

3.2.1 Reverse Link Capacity with Hard Handoff

Assume that S is the desired received signal power at user end, R is the user bit rate, W is the total spread bandwidth and there are N_c users/cell. Since for a single cell site with power control, all users are received at the same power level S , the signal-to-noise (interference) power is [1]:

$$SNR = \frac{S}{(N_c - 1)S} = \frac{1}{N_c - 1} \quad (3-6)$$

Thus the bit energy-to-noise density ratio is

$$E_b / N_o' = \frac{S / R}{(N_c - 1)S / W} = \frac{W / R}{N_c - 1} \quad (3-7)$$

where W/R is generally referred to as the "processing gain" and E_b/N_o' is the value required for adequate performance for users. For voice users this implies a BER of 10^{-3} or better. If the thermal noise N_o is considered, the bit energy-to-noise density will be

This implies that the number of users a single cell CDMA system can support is

$$E_b / N_o' = \frac{W / R}{(N - 1) + (N_o / S)} \quad (3-8)$$

$$N_c = 1 + \frac{W / R}{E_b / N_o'} - \frac{N_o}{S} \quad (3-9)$$

In order to increase the capacity, two techniques are commonly used. One is sectorization, which refers to using directional antennas for both receiving and transmitting at the cell site. (Throughout this report, we assume three sectors per cell site.) The other technique used to increase capacity is to alter transmissions when user voice activity is low. Studies show that voice users are only active 35% to 40% of the time. A voice activity factor $v=3/8$ is used for the examples in this chapter [1]. After considering both techniques, the average E_b/N_o' will be

$$E_b / N_o' = \frac{W / R}{\sum_{i=1}^{N_c-1} x_i + (N_o / S)} \quad (3-10)$$

where N_s is the number of users/sector ($N_s=1/3N_C$) and x_i represents the effect of voice activity factor with the distribution

where $v=3/8$ in our analysis.

$$x_i = \begin{cases} 1, & \text{with probability } v \\ 0, & \text{with probability } 1-v \end{cases} \quad (3-11)$$

In a multiple-cell CDMA system, a user's power is controlled by the dominant serving base station. Other subscribers whose power is controlled by other nearby base stations will introduce interference at the cell site of the desired user. When the path loss components are $n=4$ and $\sigma=8dB$, and hard handoff is applied, this other-cell interference has been justified to be a Gaussian random variable [1] with mean of interference to signal ratio $E(I/S)$ and variance of interference to signal ratio $var(I/S)$ of

$$E(I/S) \leq 0.247N_s \quad \text{and} \quad var(I/S) \leq 0.078N_s \quad (3-12)$$

The average E_b/N_o' for a multiple-cell CDMA system is

$$E_b/N_o' = \frac{W/R}{\sum_{i=1}^{N_s-1} x_i + (I/S) + (N_o/S)} \quad (3-13)$$

In order to achieve an adequate performance of $BER < 10^{-3}$ for voice users, the required E_b/N_o' should be greater than a factor of 5 or 7dB. Consequently, the outage probability is found to be $P_{out} = Pr(BER > 10^{-3}) = Pr(E_b/N_o' \leq 5)$, assuming $E_b/N_o' = 7dB$. Therefore [1],

$$P_{out} = Pr\left(\sum_{i=1}^{N_s} x_i + I/S > \delta\right) = \sum_{k=0}^{N_s-1} \binom{N_s-1}{k} v^k (1-v)^{N_s-1-k} \cdot Q\left(\frac{\delta - k - 0.247N_s}{\sqrt{0.078N_s}}\right) \quad (3-14)$$

where

$$\delta = \frac{W/R}{E_b/N_o'} - \frac{N_o}{S} \quad (3-15)$$

The first portion of equation (3-14) represents the effect of the distribution of the voice activity factor x_i which has a binomial distribution. The second portion represents the other-cell interference, which has a Gaussian distribution.

Assuming all the cells are equally loaded, the analytical result of CDMA capacity with hard handoff as calculated by equation (3-14) below is shown in Fig 3-1 [1].

The parameters in this analysis were chosen as follows:

$W=1.25$ MHz represents 10% of the total spectral allocation, 12.5MHz, for cellular telephone service of each service provider.

$R=9.6$ kb/s (8 kb/s vocoder); an acceptable nearly toll quality vocoder.

$v=3/8$; standard voice activity factor.

$S/N_o=-1$ dB; reflects a reasonable subscriber transmitter power level for the reverse channel.

$E_b/N_o'=5(7$ dB) required; ensures adequate BER requirement ($BER < 10^{-3}$).

With these assumed values, δ is calculated here as [1]

$$\delta = \frac{W/R}{E_b/N_o} - \frac{N_o}{S} = 30$$

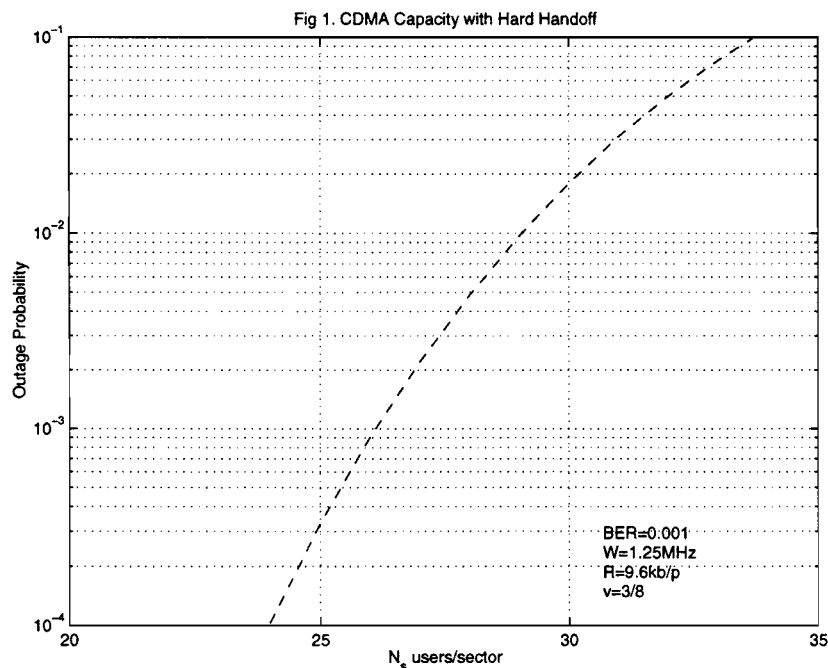

Fig 3-1. CDMA Capacity with Hard Handoff [1]

3.2.2 Reverse Link Capacity with Soft Handoff

The effect of soft handoff is tightly coupled with power control. Power control seeks to make the received signal energy-to-interference ratio the same for all the users at the controlling base station, thus combating the near-far problem [4]. During soft handoff the users are power controlled by the best base station; therefore, every other-cell user's interference will be less than the desired

user's signal. This contrasts with hard handoff, in which each user communicates with a single base station. Because hard handoff process requires hysteresis, higher transmit signal power is needed than for the soft handoff technique. The interference for each user is much higher in the hard handoff case than that of the soft handoff case (as shown in Fig 3-2). Thus the overall capacity is less.

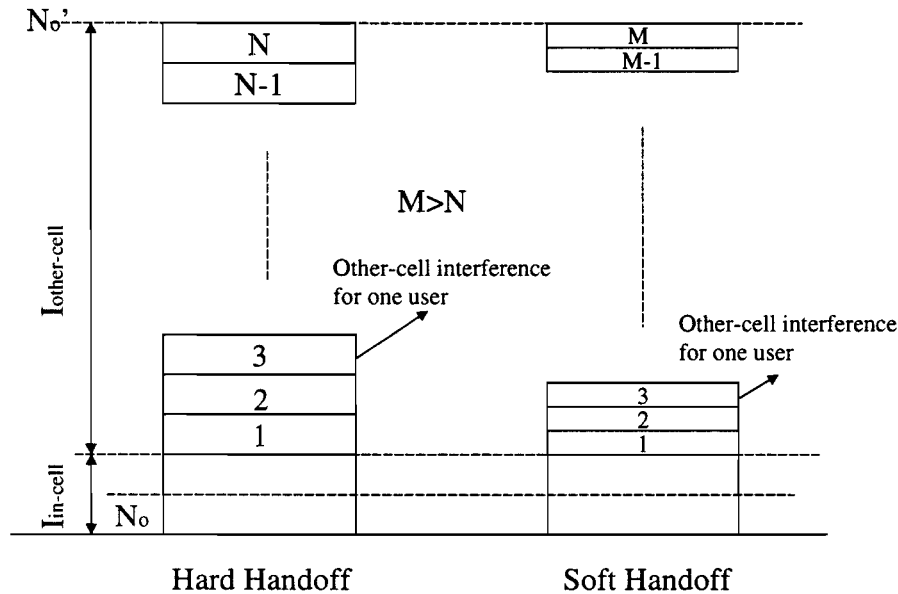

Fig 3-2. Total interference of CDMA system with soft and hand handoff

Figure 3-2 is a simplified illustration which shows that lower levels of other-cell interference with soft handoff result in larger capacity than with hard handoff for a given interference threshold N_o' .

3.2.2.1 Other-cell interference factor

In a CDMA system, all the users occupy the same spectrum. The users who are power-controlled by different base stations will introduce interference to each other. The interference introduced by the users who are power-controlled by the other base stations to the current one is called other-cell interference. Assuming there are an average of N_c users per cell, the other-cell interference factor is defined as [4]

$$f = \frac{\text{average total interference level from other-cell users}}{N_c} \quad (3-16)$$

In the hard handoff case, the mobile communicates with only one base station at any given time (Figure 3-3 illustrates a mobile near cell boundary being communicating with cell A and causing interference at cell B.). For simplicity, the signal levels at the cell boundary are assumed to be the same from each base station [5]. Assume that hard handoff occurs at the cell boundary as a mobile moves from one cell into another. (As mentioned before, in order to prevent the “Ping-Pong” effect, hard handoff normally occurs when the second cell signal level is considerably stronger than the first. Nevertheless, the ideal assumption is made for comparison.)

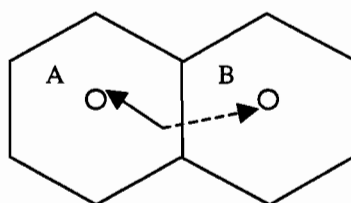

Fig 3-3. Hard Handoff Model

Let us normalize each cell’s radius (the maximum distance from any point in the cell to the base station at its center) to unity and assume a uniform density of users throughout all cells. Also denote the cell under consideration as the zeroth cell and the distance from the user to the zeroth cell base station as $r_0(x,y)$, while the distance to any other cell’s base station is denoted as $r_1(x,y)$, the other-cell interference factor for the hard handoff case is calculated as [4]

$$f = e^{b^2(\beta\sigma)^2} \left[\frac{2}{3\sqrt{3}} \iint_{\bar{S}_0} \frac{r_1^n(x,y)}{r_0^n(x,y)} dA(x,y) \right] \quad (3-17)$$

where $b = 1/\sqrt{2}$

σ is the standard deviation of lognormal shadowing

$\beta = \ln(10)/10$

\bar{S}_0 is the entire region outside the given zeroth cell

The simplest soft handoff model assumes that each mobile is in two-way handoff 100% of the time [5]. The shadowed area in Figure 3-4 shows the location where a mobile will be in soft handoff while being served by base stations A and B. We denote S_0 as the region which the user can be in soft handoff and \bar{S}_0 is the region outside S_0 . $r_0(x,y)$, $r_1(x,y)$ and $r_2(x,y)$ are the distance from the user to the zeroth cell base station and two nearest other-cell base stations.

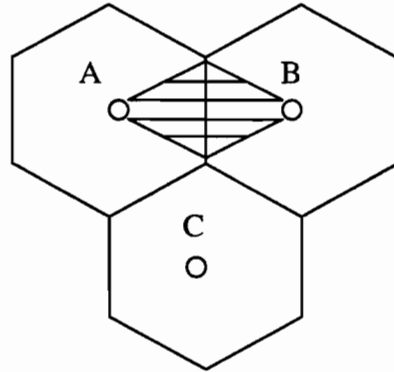

Fig 3-4. 100% Two-way soft handoff area served by A and B

The other-cell interference factor for two-way 100% soft handoff is calculated as [4]

$$f = \frac{2e^{(\beta\sigma)^2/2}}{3\sqrt{3}} \left[\iint_{s_o} \frac{r_1^n(x,y)}{r_o^n(x,y)} Q\left(\beta\sigma + \frac{M_1 - M_0}{\sigma}\right) dA + \iint_{s_o} \frac{r_1^n(x,y)}{r_o^n(x,y)} Q\left(\beta\sigma/2 + \frac{M_1 - M_2}{\sigma}\right) dA \right. \\ \left. + \iint_{s_o} \frac{r_2^n(x,y)}{r_o^n(x,y)} Q\left(\beta\sigma/2 + \frac{M_2 - M_1}{\sigma}\right) dA \right] \quad (3-18)$$

where $M_i(x, y) = 10n \log_{10} r_i(x, y)$

When the path loss component n is 4 (see section 3.1) and σ changes from 0dB to 12dB, the other-cell interference factors have been calculated by equation (3-17) and (3-18) and sample results are shown in Table 1.

Log-normal shadowing standard deviation (dB)	0	2	4	6	8	10	12
Hard handoff other-cell interference factor f_{hard}	0.44	0.48	0.67	1.13	2.38	6.17	19.8
100% two-way soft handoff other-cell interference factor f_{soft}	0.44	0.43	0.47	0.56	0.77	1.28	2.62

Table 1. Other-cell Interference Factor (n=4)

From Table 1 we can see when σ is increasing, the other-cell interference factor is increasing as well. Other-cell interference factors of soft handoff are much less than that of hard handoff.

3.2.2.2 Reverse link capacity with soft handoff

In hard handoff, when the standard deviation of log-normal shadowing is $\sigma=8dB$ the other-cell interference I has been found to have a Gaussian distribution [1] with mean equals to $0.274N_s$ and variance equals to $0.078N_s$.

As shown in Table 1, when $\sigma=8dB$ and $n=4$ the hard handoff other-cell interference factor has been found to be $f_{hard}=2.38$, while with 100% two-way soft handoff the other-cell interference factor is $f_{soft}=0.77$.

With soft handoff, the mobile is served by the best base station and each other-cell user's interference is limited to a normalized value less than unity. If the total other-cell interference with hard handoff is I , with soft handoff other-cell interference is reduced to kI , where k is defined as f_{soft}/f_{hard} . For soft handoff, the hard handoff other-cell interference parameters of Equation (3-12) are modified by the interference reduction factor, $k=f_{soft}/f_{hard}$, resulting in

$$E(I/S) = \frac{f_{soft}}{f_{hard}} \cdot 0.247N_s \quad \text{and} \quad \text{var}(I/S) = \left(\frac{f_{soft}}{f_{hard}}\right)^2 \cdot 0.078N_s \quad (3-19)$$

Adjusting equation (3-14) for the soft handoff case, the outage probability becomes

$$P_{out} = P_r\left(\sum_{i=1}^{N_s} x_i + I/S > \delta\right) = \sum_{k=0}^{N_s-1} \binom{N_s-1}{k} v^k (1-v)^{N_s-1-k} \cdot Q\left(\frac{\delta - k - \frac{f_{soft}}{f_{hard}} \cdot 0.247N_s}{\sqrt{0.078N_s \cdot \left(\frac{f_{soft}}{f_{hard}}\right)^2}}\right) \quad (3-20)$$

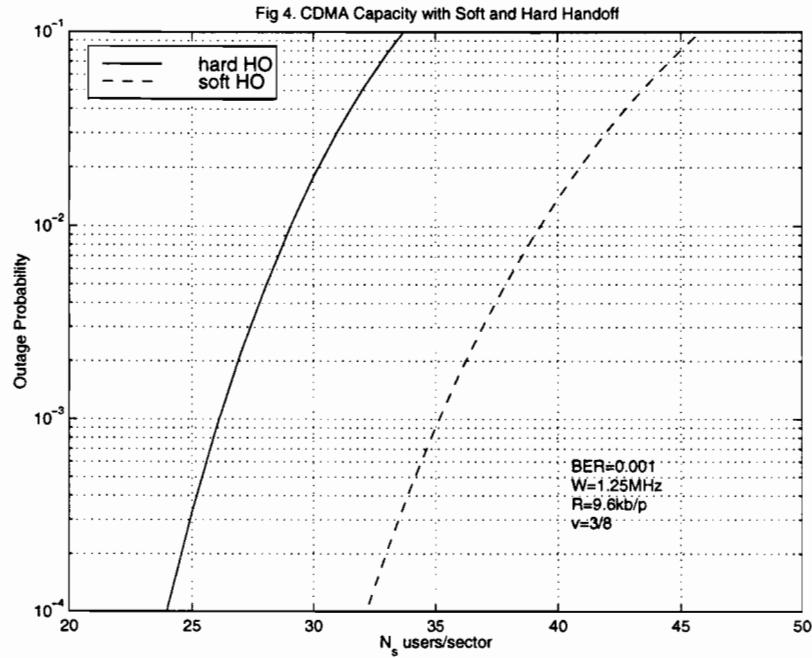

Fig 3-5. CDMA Capacity with Soft and Hard Handoff ($n=4$, $\sigma=8$ dB)

Figure 3-5 is the analytical result of CDMA capacity with 100% two-way soft handoff. The parameters used here are the same as in the hard handoff case.

We can see when the outage probability is 1%, the system can support 29 users/sector with hard handoff or 39 users/sector with soft handoff. Thus, the soft handoff case provides a 34% increase in capacity over the hard handoff case.

3.2.3 Reverse Link Capacity Validation Test

By comparing our result (as shown in Figure 3-5) with Viterbi's [8], the analysis and results from the previous section will be verified.

3.2.3.1 Viterbi's Reverse Link Erlang Capacity

In order to consider both service availability and quality, Viterbi et al chose Erlang capacity as the standard for measurement instead of total number of users/cell in their paper [8]. According to the classical Erlang analysis of the M/M/S/S queue (the first M refers to a Poisson arrival rate of λ calls/s, the second M refers to exponential service rate with μ calls/s, the first S refers to the number of channels, the second S refers to the maximum number of users supported by the system before blockage occurs), the Erlang B formula is

$$P_{blocking} = \frac{(\lambda / \mu)^S / S!}{\sum_{k=0}^S (\lambda / \mu)^k / k!} \quad (3-21)$$

The formula for the normalized average load (λ/μ in terms of Erlangs per sector) is given by Viterbi et al [8] as

$$\frac{\lambda}{\mu} v(1+f) = K_o \times F(B, \sigma_c) \quad (3-22)$$

where

λ/μ is the average load in term of Erlangs/sector

$$B = \frac{[Q^{-1}(P_{out})]^2}{K_o}$$

v is the voice activity factor

f is the other-cell interference factor

$$K_o = \frac{W/R}{E_b/N_o} \times \left(1 - \frac{N_a}{I_o}\right)$$

and

$$F(B, \sigma_c) = \frac{1}{\alpha_c} \left[1 + \frac{\alpha_c^3 B}{2} \left(1 - \sqrt{1 + \frac{4}{\alpha_c^3 B}}\right)\right]$$

The parameter σ_c is the power control variable used to quantify imperfect power control. It is assumed to have a lognormal distribution with a mean equal to the desired E_b/N_o level and a standard deviation with typical values ranging from 1.5dB to 2.5dB [8]. In order to compare their results with our results, σ_c is set to 0dB, thereby assuming perfect power control.

Also,

$$\alpha_c = e^{(\beta\sigma_c)^2/2} \quad \text{and} \quad \beta = \ln(10)/10 = 0.2303$$

To provide a fair comparison, $f_{hard}=2.38$ and $f_{soft}=0.77$ [4] are set and all other parameters are chosen to be the same as in our analysis. The desired interference-to-noise $I_o/N_o=1/\eta$ is chosen to be 10dB to represent the worst case. (Typically, η is between 0.25 and 0.1 which corresponds to spectral density ratios of (I_o/N_o) between 6dB and 10dB. When the ratio exceeds this level, the interference per additional user increases rapidly, thus leading to instability [8].) The analytical result is shown in Figure 3-6.

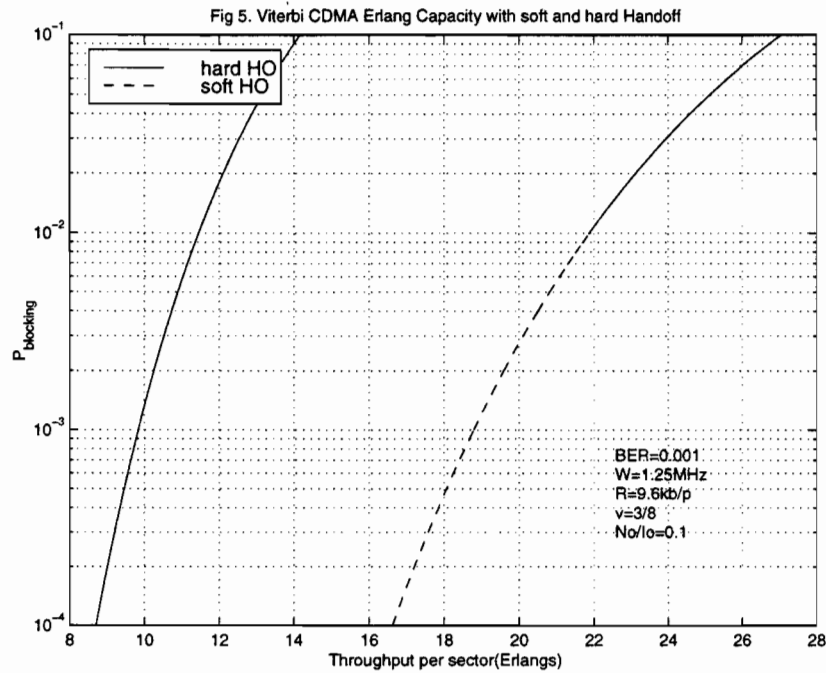

Fig 3-6. Viterbi CDMA Erlang Capacity with Soft and Hard Handoff

We can further calculate the required received signal power-to-background noise per user S/N_oW by using equation (3-23).

$$\frac{S}{N_oW} = \frac{1}{v(\lambda/\mu)} \left(\frac{I_o}{N_o} - 1 \right) \quad (3-23)$$

The results are shown in Figure 3-7. Figure 3-7 shows that with soft handoff the required received S/N_oW is 3dB lower than with the hard handoff case. Therefore, with soft handoff less transmitted power is needed, thus reducing power requirements in the handset and the total system interference. Notice in our analysis which is described in section 3.2.2, the required signal power-to-background noise per user S/N_oW is fixed at -1dB.

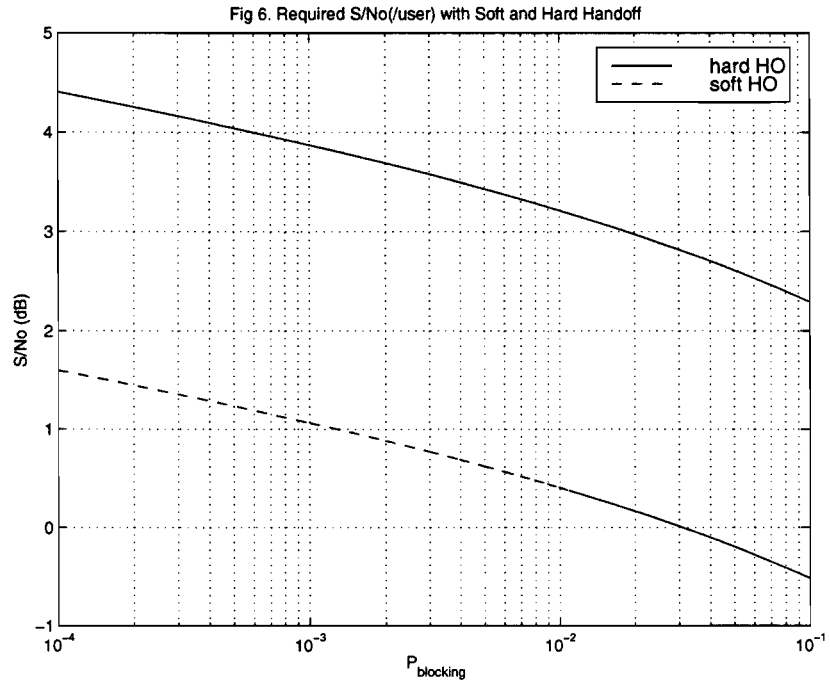

Fig 3-7. Required S/N_o (per user) with Soft and Hard Handoff

3.2.3.2 Validation Test

In our analysis, CDMA capacity was found in terms of the number of users per sector. In Viterbi's analysis, CDMA capacity in terms of Erlangs per sector is calculated. In order to compare these two results, the Erlang capacity of our previous analysis was calculated using the Erlang B formula shown in (3-21). The results of this calculation are shown in Figure 3-8. Notice that the results are obtained under the assumption that the required received power-to-noise per user (S/N_oW) is fixed at -1 dB. Given the link attenuation, the received sensitivity and the antenna gain, the transmitted power is fixed in this case.

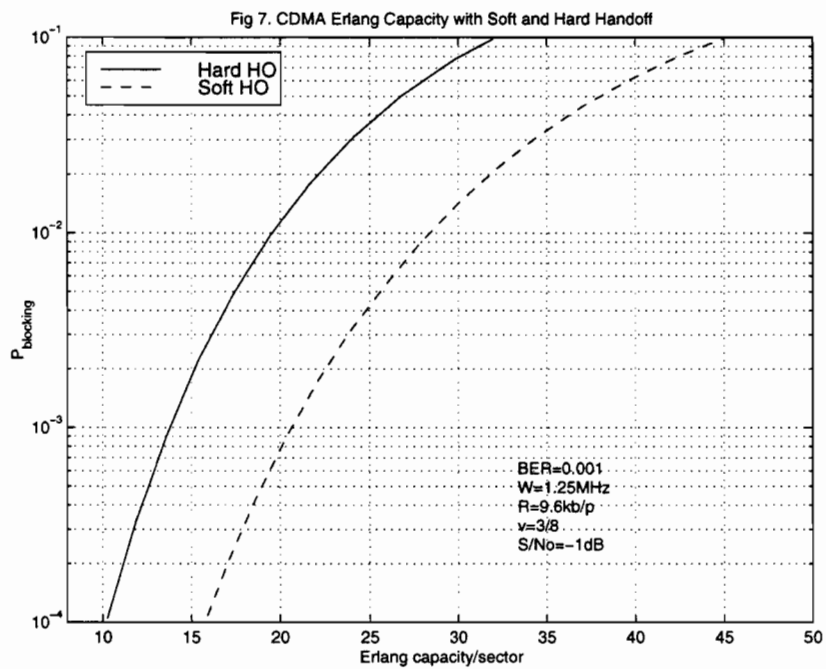
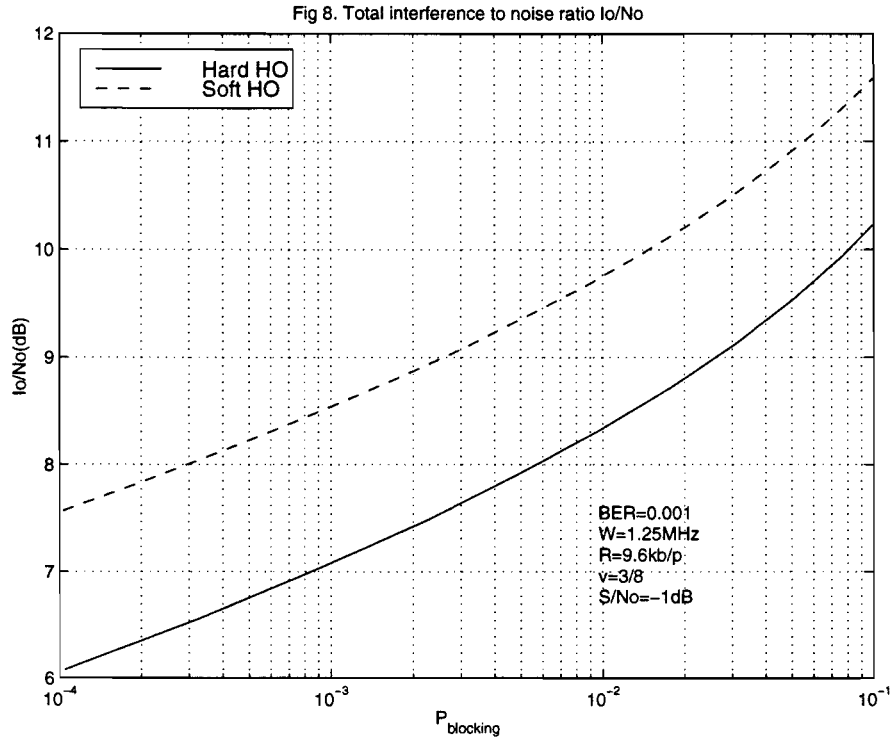

Fig 3-8. CDMA Erlang Capacity with Soft and Hard Handoff



In addition, following our analysis the total interference-to-noise ratio I_o/N_o can be calculated from (3-24) as

$$\frac{I_o}{N_o} = v \frac{\lambda}{\mu} \frac{S}{N_o W} + 1 \quad (3-24)$$

Results of this calculation are shown in Figure 3-9. Note that the total interference level for hard handoff is 1.5dB higher than the level of the soft handoff case.

A comparison of Viterbi's results in Figure 3-6 with ours in Figure 3-8 indicates that they do not match. This discrepancy might be explained by noting that in Viterbi's calculations the total I_o/N_o level is fixed at 10dB, and the required received signal power-to-background noise per user varies (as shown in Figure 3-7) from 2.5dB to 4dB with hard handoff and from -0.5dB to 1.5dB with soft handoff. On the other hand, in our analysis $S/N_o W$ is fixed at -1dB and the total interference level varies as shown in Figure 3-9. Comparing all the points which satisfy both criteria of $I_o/N_o=10dB$ and $S/N_o W=0.5dB$ to 1.5dB for soft handoff, $S/N_o W=2.5dB$ to 4dB for hard handoff, the two methods are found to match well. The comparison results are shown in Figure 3-10 and Figure 3-11.

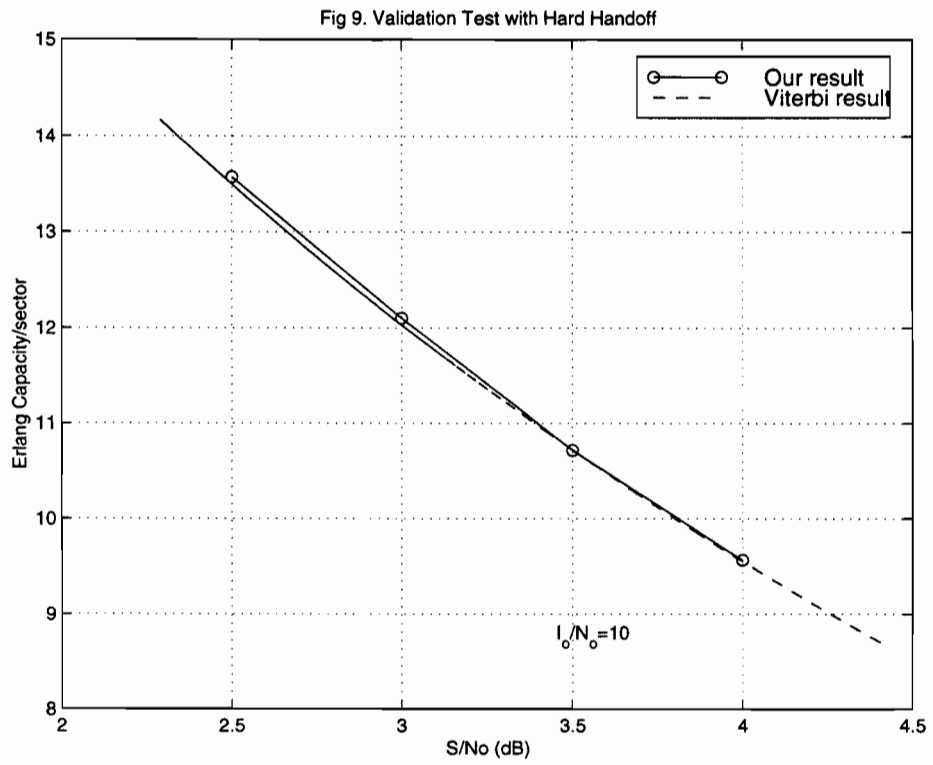

Fig 3-10. Validation Test with Hard Handoff

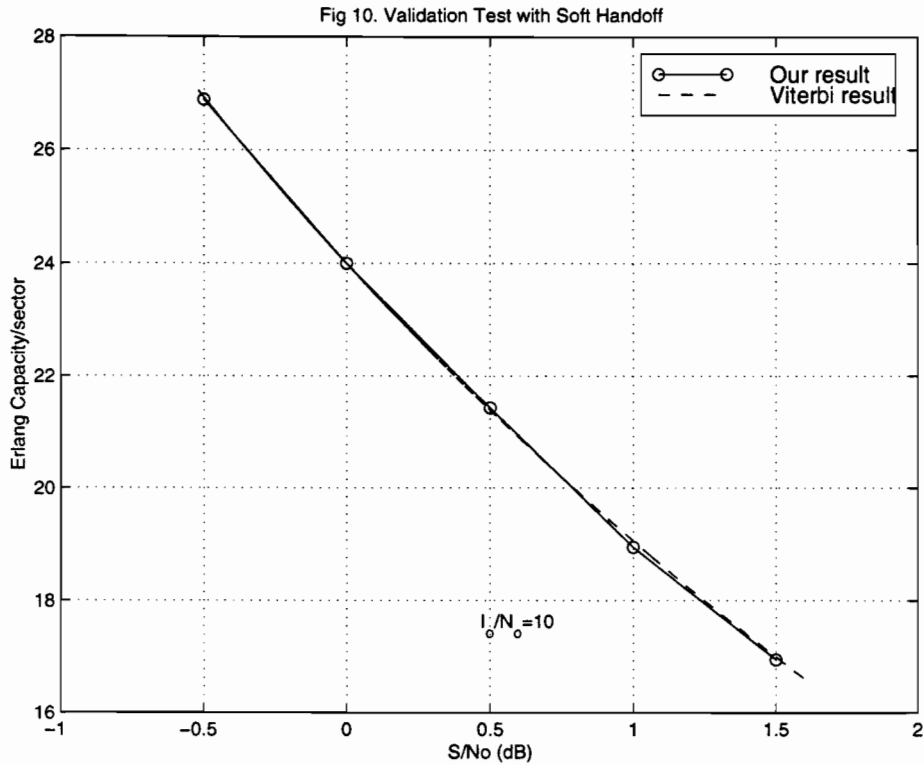

Fig 3-11. Validation Test with Soft Handoff

3.3 Soft Handoff Median Range Effect on Reverse Link Capacity

In the previous section, the simplest case -- 100% two-way soft handoff -- was assumed in order to compare soft handoff with hard handoff. In this section, the soft handoff area will be changed and the corresponding change of CDMA capacity will be calculated.

3.3.1 Other-cell Interference Factor

As defined in Equation (3-16), the other-cell interference factor is the ratio of the average total interference from other-cell users to the desired cell users. This factor is obtained by calculating the total interference that the other-cell users introduce to the in-cell users over the other-cell area. Viterbi *et al* have calculated the other-cell interference factor for hard handoff and 100% two-way soft handoff

as shown in Table 1 [5]. When the soft handoff area changes from 100% to 0%, handoffs change from 100% soft handoff to hard handoff. Correspondingly, the other-cell interference factors f changes from 2.38 to 0.77. The mathematical approach to calculate f is shown in the following section. First, the simplest cases -- hard handoff and 100% two-way soft handoff -- are considered. Then with the change of soft handoff area, f is calculated accordingly.

3.3.1.1 Hard Handoff Other-cell Interference Factor

In this case, a single cell is assumed to be received at any given time, with hard handoff between cells being performed at the hexagonal cell boundary as shown in Figure 3-12. With the shadowed area of the central cell (zeroth cell), a mobile only communicates with cell zero base station. Also assume the six nearest cells around the central cell are the only other cells contributing to the interference. The users in this area will be the source of other-cell interference to the zeroth cell users. In addition, the radius of each cell is normalized to unity and the users throughout all cells are uniformly distributed.

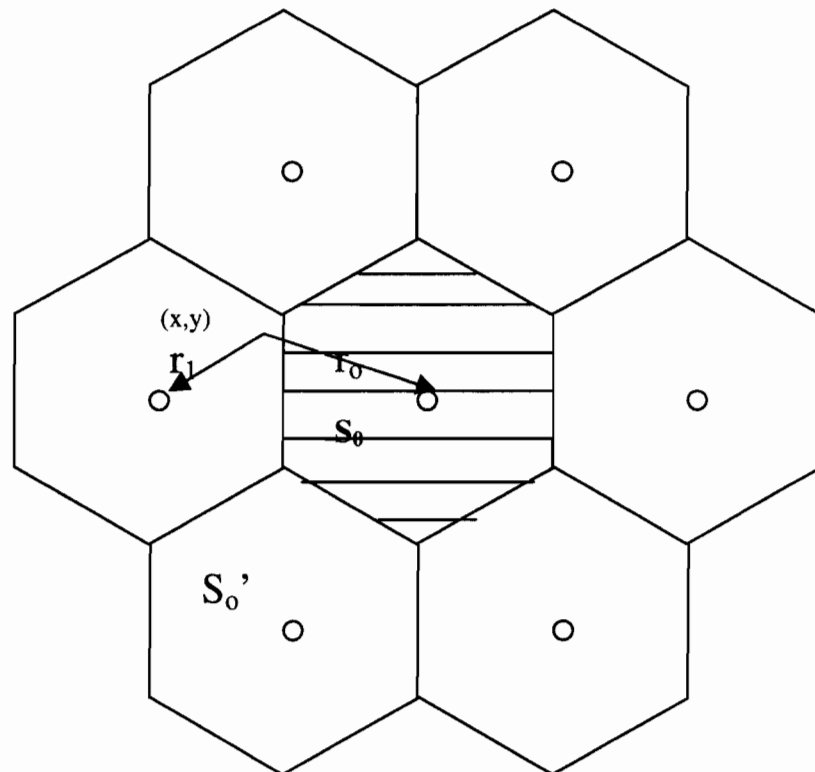

Fig 3-12. Hard Handoff Model

The distance from the user at coordinates (x,y) to the zeroth cell base station is denoted by $r_0(x,y)$ and the distance to any other base station is $r_i(x,y)$ ($i \leq 6$). The relative average interference at the zeroth cell due to all users in all other cells (denoted as the region S_0') is derived as [5]:

$$I_{S_0'} = E \iint_{S_0'} \left[\frac{r_1^n(x,y) 10^{\zeta_1/10}}{r_0^n(x,y) 10^{\zeta_0/10}} \right] k dA(x,y) \quad (3-25)$$

where ζ_0 and ζ_1 refer to the corresponding random propagation components in dB.

k is the user density and is given by

$$k = \frac{2K_u}{3\sqrt{3}} \text{ users/unit area}$$

The other-cell interference factor is calculated [5] and shown in Fig 3-13.

$$f = \frac{I_{S_0'}}{k_u} = e^{b^2(\beta\sigma)^2} \left[\frac{2}{3\sqrt{3}} \iint_{S_0'} \frac{r_1^n(x,y)}{r_0^n(x,y)} dA(x,y) \right] \quad (3-26)$$

where n is the path loss component

$$b = 1/\sqrt{2}$$

$$\beta = \ln(10)/10$$

Although we only consider six nearest cells as other cells which contribute interference, from Figure 3-13 we can see our results are very close to Viterbi's results for hard handoff case.

3.3.1.2 100% Soft Handoff Other-cell Interference Factor

Again we are taking the zeroth cell into consideration. Since we assume the 100% soft handoff case as shown in Figure 3-14, the mobile within the shadowed area always communicates with the zeroth cell and one of the six nearest base stations. When the mobile moves out of the shadowed area, it communicates with two of the nearest base stations (Not including the zeroth base station). The distance from the user at coordinates (x,y) to the zeroth base station

is $r_0(x,y)$ and the distance to the first and second nearest base stations are $r_1(x,y)$ and $r_2(x,y)$.

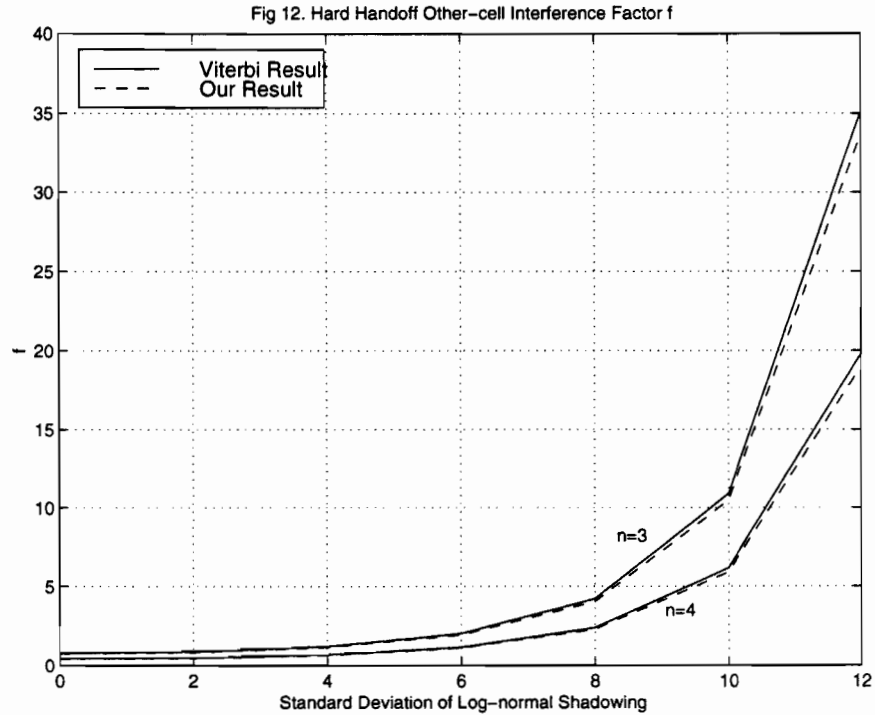

Fig 3-13. Hard Handoff Other-cell Interference Factor f

Within the shadowed area S_0 , any user who is communicating with one of the six nearest neighbors will introduce interference into the zeroth base station. But this happens only when the user is power-controlled by the nearest base station, which implies that the propagation loss to that neighbor is less than that to the zeroth base station. Thus the mean total interference from within the S_0 region to the zeroth base station is [5]

$$I_{S_0} = \iint_{S_0} \frac{r_1^n(x,y)}{r_0^n(x,y)} E[10^{(\zeta_1 - \zeta_0)/10}; r_1^n(x,y)10^{\zeta_1/10} < r_0^n(x,y)10^{\zeta_0/10}] kdA(x,y) \quad (3-27)$$

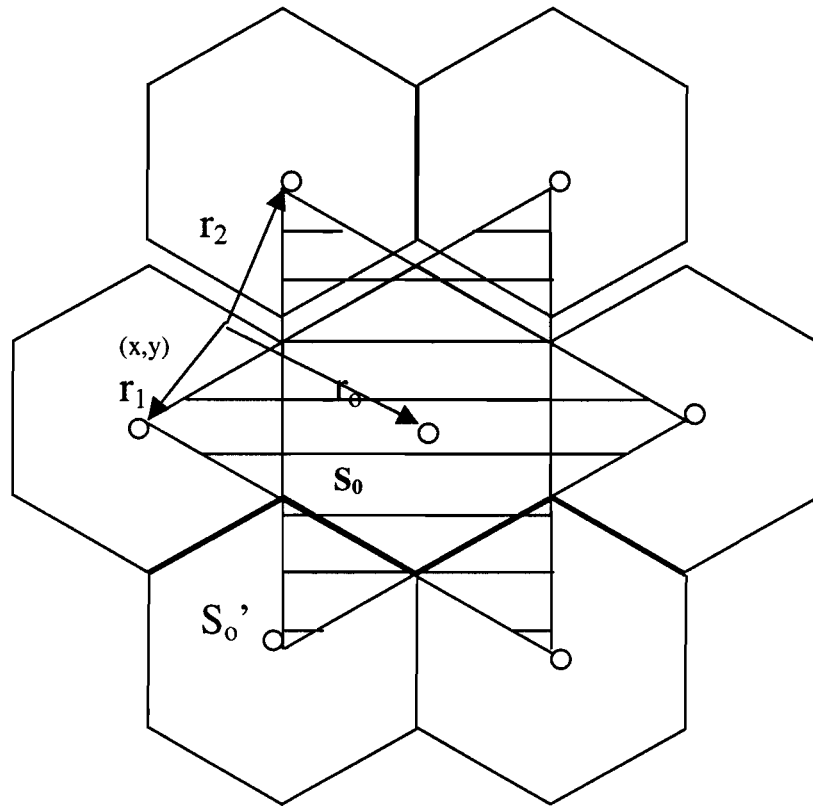

Fig 3-14. 100% Two-way Soft Handoff Model

For the complement any region S_0' , the two nearest base stations involved in a soft handoff do not include the zeroth cell. We have soft handoff between two neighboring base stations. Also, the users in this area will introduce interference to the zeroth cell. The mean interference to the zeroth base station from the S_0' region is calculated as [5]

$$I_{S_0'} = \iint_{S_0'} \frac{r_1^n(x,y)}{r_0^n(x,y)} E[10^{(\zeta_1 - \zeta_0)/10}; r_1^n(x,y)10^{\zeta_1/10} < r_2^n(x,y)10^{\zeta_2/10}] kdA(x,y) +$$

$$\iint_{S_0'} \frac{r_2^n(x,y)}{r_0^n(x,y)} E[10^{(\zeta_2 - \zeta_0)/10}; r_2^n(x,y)10^{\zeta_2/10} < r_1^n(x,y)10^{\zeta_1/10}] kdA(x,y) \quad (3-28)$$

If we define $M_i(x,y) = 10 \log_{10} r_i(x,y)$ and use the same β as before, the other-cell interference factor for 100% soft handoff is

$$f = \frac{I_{S_0} + I_{S_0'}}{k_u} = \frac{2e^{(\beta\sigma)^2/2}}{3\sqrt{3}} \times \left[\iint_{S_0} \frac{r_1^n(x,y)}{r_0^n(x,y)} Q\left(\beta\sigma + \frac{M_1 - M_0}{\sigma}\right) dA + \iint_{S_0} \frac{r_1^n(x,y)}{r_0^n(x,y)} Q\left(\beta\sigma/2 + \frac{M_1 - M_2}{\sigma}\right) dA + \iint_{S_0} \frac{r_2^n(x,y)}{r_0^n(x,y)} Q\left(\beta\sigma/2 + \frac{M_2 - M_1}{\sigma}\right) dA \right] \quad (3-29)$$

f is evaluated when $n=3$ or 4 and shown in Figure 3-15. We can see that f -values are significantly less than in the hard handoff case. When $\sigma=8$ dB and $n=4$, our results are close to Viterbi's.

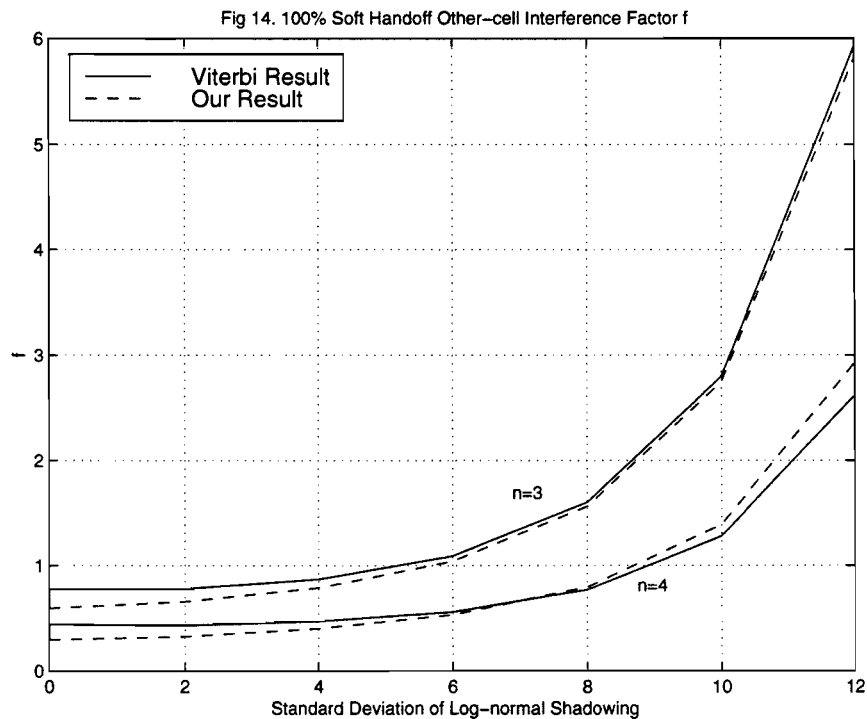

Fig 3-15. 100% Soft Handoff Other-cell Interference Factor f

3.3.2 Soft Handoff Median Range Effect on Reverse Link Capacity

Between hard handoff and 100% soft handoff, the other-cell interference factor has decreased dramatically, resulting in an increase of CDMA capacity. But in a real CDMA system, it is not realistic for mobiles to perform soft handoff all the time. In this section, we will analyze how the CDMA capacity changes under variations in the soft handoff region.

The analysis model is shown in Figure 3-16.

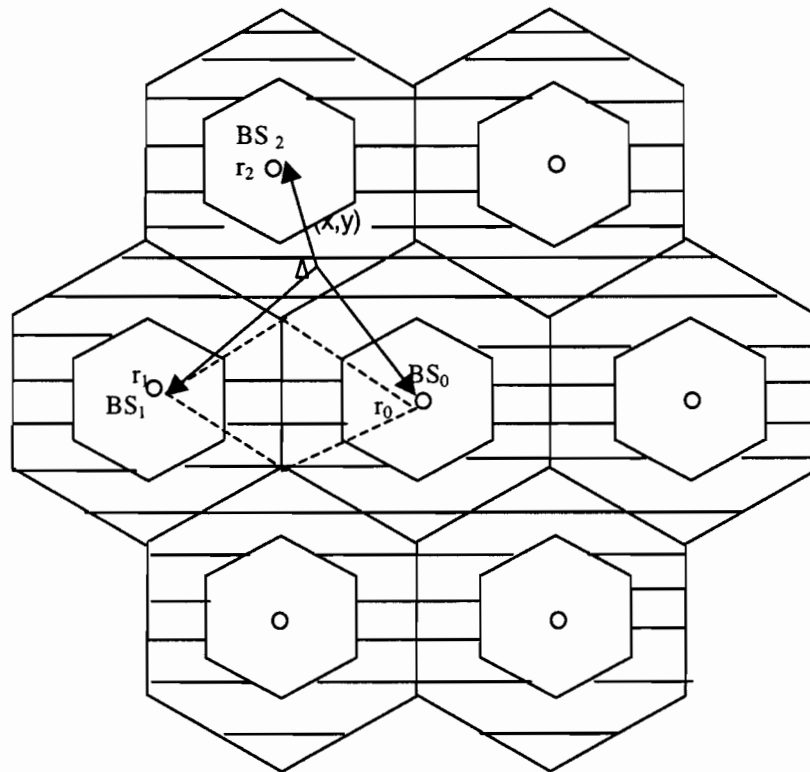

Fig 3-16. Two-way Soft Handoff Model

Two-way soft handoff is performed within the area represented by the hatch marks. Outside that area, a mobile can only communicate with its own base station. As the hatched area increases, the soft handoff region increases accordingly. When this area size is zero, the mobile communicates with only one base station all the time, which is the hard handoff case. When the hatched area size equals the cell size, the mobile will communicate with two base stations at any given time, in which case 100% soft handoff is performed.

We divide the whole area into four different regions and analyze them separately.

- First area (S_0)---the small hexagon within the zeroth cell: in this area, the mobile will only communicate with base station zero. The users within this region will only introduce in-cell interference to each other, so we do not consider the users in this area when we calculate other-cell interference factor.
- Second area (S_1)---small hexagon within six nearest cells: in this area, the mobile will only communicate with its own base stations. The users in this area will introduce other-cell interference I_1 to the zeroth cell users.

- Third area (S_2)—hatched area between the zeroth cell and six nearest cells: in this area, the mobile will communicate with two base stations at the same time. One is the zeroth base station; the other one is one of the six nearest cells. Obviously the mobiles in this area will introduce interference I_2 to the zeroth cell users.
- Fourth area (S_3)—hatched area between two base stations, from which the zeroth cell excluded: the users in this area will introduce interference I_3 to the zeroth cell users.

Similar to hard handoff case, the relative average interference within S_1 is [4]

$$I_1 = E \iint_{S_1} \left[\frac{r_m^n(x, y) 10^{\zeta_m/10}}{r_0^n(x, y) 10^{\zeta_0/10}} \right] k dA(x, y); \quad \text{where } m \in [1, 6] \quad (3-30)$$

Within S_2 , the average interference will be [4]

$$I_2 = \iint_{S_2} \frac{r_m^n(x, y)}{r_0^n(x, y)} E[10^{(\zeta_m - \zeta_0)/10}; r_m^n(x, y) 10^{\zeta_m/10} < r_0^n(x, y) 10^{\zeta_0/10}] k dA(x, y) \quad (3-31)$$

Within S_3 , the average interference will be [4]

$$I_3 = \iint_{S_3} \frac{r_m^n(x, y)}{r_0^n(x, y)} E[10^{(\zeta_m - \zeta_t)/10}; r_m^n(x, y) 10^{\zeta_m/10} < r_t^n(x, y) 10^{\zeta_t/10}] k dA(x, y) +$$

$$\iint_{S_3} \frac{r_t^n(x, y)}{r_0^n(x, y)} E[10^{(\zeta_m - \zeta_t)/10}; r_t^n(x, y) 10^{\zeta_t/10} < r_m^n(x, y) 10^{\zeta_m/10}] k dA(x, y) \quad (3-32)$$

where $m, t \in [1, 6]$ and $m \neq t$

Therefore, the other-cell interference factor is calculated as

$$f = \frac{I_1 + I_2 + I_3}{k_u} = \frac{2e^{(\beta\sigma)^2/2}}{3\sqrt{3}} \times \left[\iint_{S_1} \frac{r_m^n(x, y)}{r_0^n(x, y)} dA + \iint_{S_2} \frac{r_m^n(x, y)}{r_0^n(x, y)} Q\left(\beta\sigma + \frac{M_m - M_0}{\sigma}\right) dA \right.$$

$$\left. + \iint_{S_3} \frac{r_m^n(x, y)}{r_0^n(x, y)} Q\left(\beta\sigma/2 + \frac{M_m - M_t}{\sigma}\right) dA + \iint_{S_3} \frac{r_t^n(x, y)}{r_0^n(x, y)} Q\left(\beta\sigma/2 + \frac{M_t - M_m}{\sigma}\right) dA \right] \quad (3-33)$$

The analytical result for f is shown in Figure 3-17. It shows that when the soft handoff region is larger than 50% of the cell size, the other-cell interference factor is close to its minimum value of 0.79.

Furthermore, by using these other-cell interference factors, the CDMA capacity is evaluated as shown in Figure 3-18. The left-most curve represents the

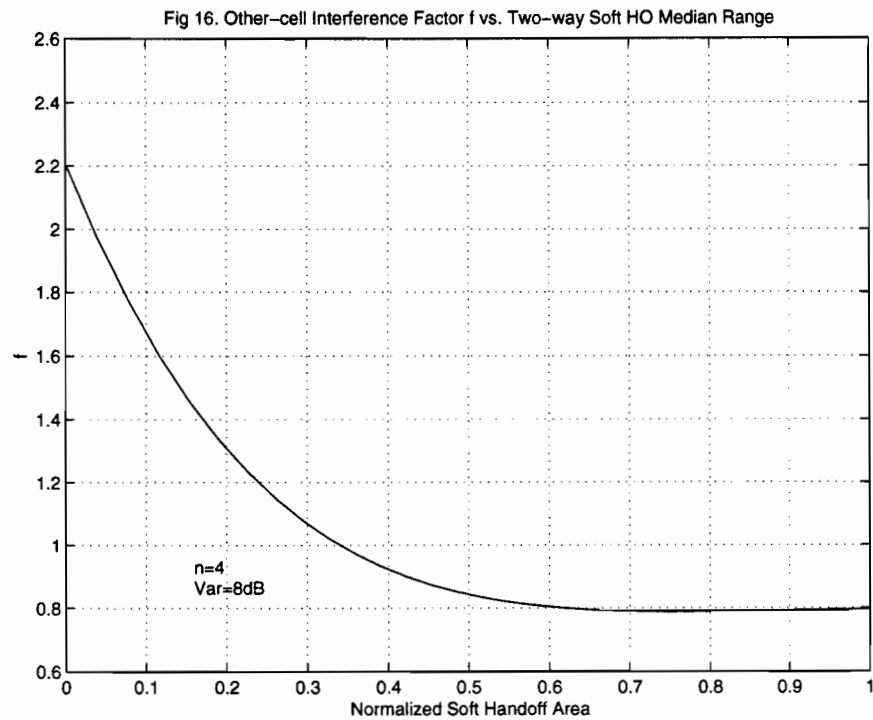

Fig 3-17. Other-cell Interference Factor vs. Two-way Soft Handoff Median Range

soft handoff region equaling zero, which is hard handoff case. The right most curve is the 100% soft handoff case. Varying from hard handoff to 100% soft handoff, the capacity increases continuously.

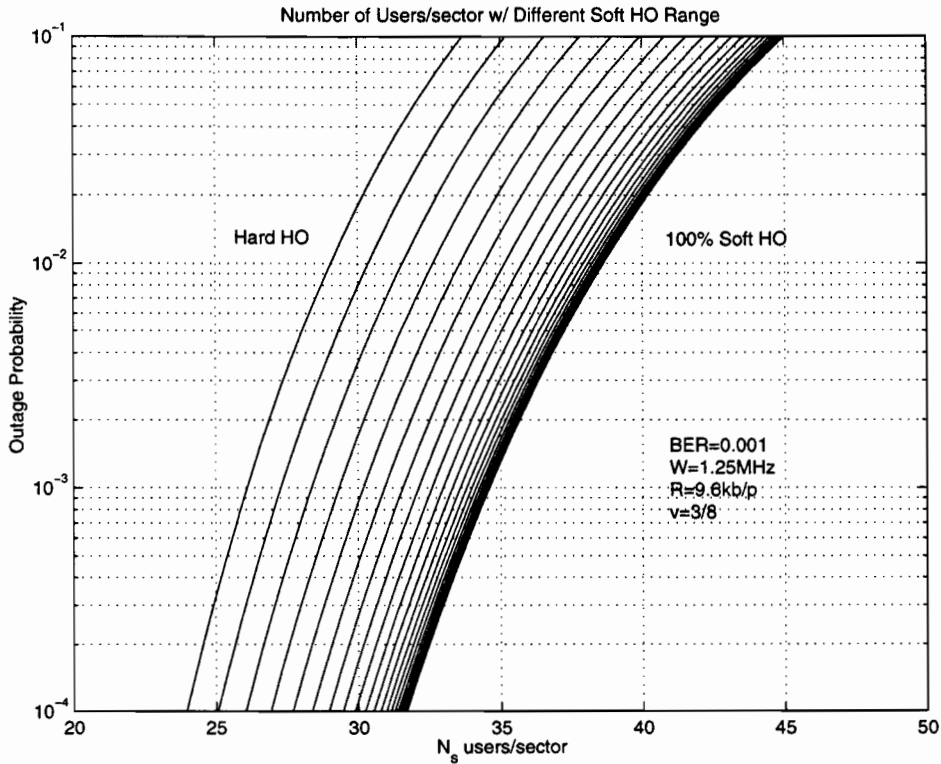

Fig 3-18. Number of Users per Sector with Difference Soft Handoff Range

When we keep the outage probability as 0.1, 0.01 and 0.001, the CDMA capacity vs. the soft handoff region is found in Figure 3-19. We can see the capacity remains approximately a constant when the soft handoff region exceeds 50% for either case. These constants are the maximum number of users can be supported under certain outage probability. For example, when $P_{outage}=0.1$, 36 users per sector can be supported simultaneously.

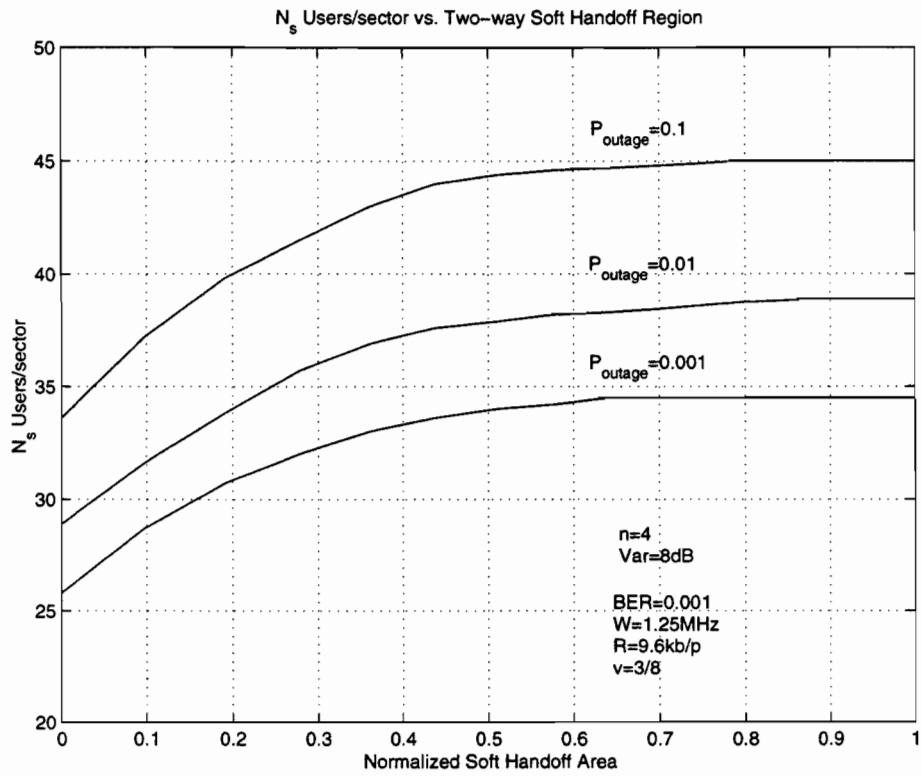

Fig 3-19. Number of users per sector vs. Two-way soft handoff median range

Chapter 4 Reverse Link Capacity Analysis for Multiple Classes of Users

In chapter 3 we analyzed CDMA capacity with soft handoff and hard handoff for voice users only. In this chapter more than one class of users are considered, e.g. voice users, data users and video users. These different classes of users have different data rates, different activity factors and different BER requirements. These factors affect the capacity for all user classes in a CDMA system. The capacity of every class user vs. data rate, activity factor, or BER requirements is calculated numerically in this chapter, under the assumptions of 100% two-way soft handoff and hard handoff. Furthermore, when the soft handoff region changes, the user capacity of different classes in the system is calculated as well.

4.1 Propagation Model

As described in chapter 3, path loss often varies as the fourth power of distance and exhibits a lognormal shadowing effect. Assume that during hard handoff, a single cell is being received at any given time for every class of users, with hard handoffs being performed at the cell boundary [4]. For comparison purposes, 100% two-way soft handoff is again assumed when we study the effect of BER requirements, activity factors and user data rates on the capacity for every class of users.

4.2 CDMA Capacity for Multiple Classes of Users

CDMA capacity for multiple classes of users has been studied in [3]. Their bandwidths and their fidelity requirements define these different classes of users. Assuming perfect power control in the CDMA system for all users, the capacity constraint was found. The results are summarized in the following sections.

4.2.1 CDMA Capacity for One Class of Users

For the single cell CDMA system the bit energy-to-noise density is derived in equation (3-8). Because the signal power level $S=E_b R/W$, E_b/N_o' can also be represented as

where γ is the required E_b/N_o' value in order to achieve adequate performance (e.g. $BER < 10^{-3}$ for voice users) and $G_p=W/R$ is the processing gain. Therefore,

$$\begin{aligned} E_b / N_o' &= \frac{W / R}{(N_c - 1) + (E_b / N_o')^{-1} \frac{W}{R}} \\ &= \frac{G_p}{G_p (E_b / N_o')^{-1} + (N_c - 1)} \geq \gamma \end{aligned} \quad (4-1)$$

the maximum number of users is derived from equation (4-1) as

$$N_c = 1 + G_p \left(\frac{1}{\gamma} - \frac{1}{E_b / N_o} \right) \quad (4-2)$$

Taking into account the effect of sectorization, voice activity factor and the interference from the other-cell users, the capacity of multiple cells CDMA system is calculated as[3]:

$$N_c = \frac{1}{1+f} \left[1 + \frac{nG_p}{v} \left(\frac{1}{\gamma} - \frac{1}{E_b / N_o} \right) \right] \quad (4-3)$$

where N_c is the number of users/cell
 f is other-cell interference factor
 n is number of sectors/cell
 v is voice activity factor

4.2.2 CDMA Capacity for More than One Class of Users

We first consider two classes of users. Assume there are N_1 class 1 users and N_2 class 2 users with data rate R_1 and R_2 respectively. Let their activity factors be v_1 and v_2 . G_{p1} and G_{p2} represent the corresponding processing gains. M_1 and M_2 are the total number of class 1 and 2 users including interference. S_1 and S_2 are the despread signal power spectral density (PSD) heights of class 1 and class 2 users.

In a single cell CDMA system, the total interference for class 1 users can be written as [3]

$$N_{o1}' = N_o + \frac{S_1 R_1}{W} (M_1 - 1) + \frac{S_2 R_2}{W} M_2 \quad (4-4)$$

Similarly for class 2 users

$$N_{o2}' = N_o + \frac{S_2 R_2}{W} (M_2 - 1) + \frac{S_1 R_1}{W} M_1 \quad (4-5)$$

The average bit energy-to-noise ratio can be calculated as [3]

$$(E_b / N_o)_1 = \frac{1}{\frac{N_o}{S_1} + \frac{(M_1 - 1)}{G_{p1}} + \frac{S_2 M_2}{S_1 G_{p2}}} \geq \gamma_1 \quad (4-6)$$

and

$$(E_b / N_o)_2 = \frac{1}{\frac{N_o}{S_2} + \frac{(M_2 - 1)}{G_{p2}} + \frac{S_1 M_1}{S_2 G_{p1}}} \geq \gamma_2 \quad (4-7)$$

If we consider sectorization and activity factors and assume the other-cell interference factors are the same for both classes of users, equation (4-7) and (4-8) can be written as [3]

$$(E_b / N_o)_1 = \frac{1}{\frac{N_o}{S_1} + \frac{v_1[(1+f)N_1 - 1]}{nG_{p1}} + \frac{v_2 S_2 [(1+f)N_2]}{nS_1 G_{p2}}} \geq \gamma_1 \quad (4-8)$$

and

$$(E_b / N_o)_2 = \frac{1}{\frac{N_o}{S_2} + \frac{v_2[(1+f)N_2 - 1]}{nG_{p2}} + \frac{v_1 S_1 [(1+f)N_1]}{nS_2 G_{p1}}} \geq \gamma_2 \quad (4-9)$$

The number of users is [3]

$$N_1 \leq \frac{1}{1+f} \left(1 + \frac{nG_{p1}}{v_1} \left[\frac{1}{\gamma_1} - \frac{1}{(E_b / N_o)_1} \right] \right) - \frac{v_2 G_{p1} S_2 N_2}{v_1 G_{p2} S_1} \quad (4-10)$$

$$N_2 \leq \frac{1}{1+f} \left(1 + \frac{nG_{p2}}{v_2} \left[\frac{1}{\gamma_2} - \frac{1}{(E_b / N_o)_2} \right] \right) - \frac{v_1 G_{p2} S_1 N_1}{v_2 G_{p1} S_2} \quad (4-11)$$

Equations (4-10) and (4-11) can be written in the form [3]

$$N_1 + bN_2 \leq \bar{N}_1 \quad (4-12) \quad \text{and} \quad N_2 + dN_1 \leq \bar{N}_2 \quad (4-13)$$

where

$$b = \frac{1}{d} = \frac{v_2 G_{p1} S_2}{v_1 G_{p2} S_1}$$

and \bar{N}_1 and \bar{N}_2 are the number of users of class 1 and class 2 when there are no class 2 and class 1 users respectively.

$$\bar{N}_j = \frac{1}{1+f} \left(1 + \frac{nG_{pj}}{v_j} \left[\frac{1}{\gamma_j} - \frac{1}{(E_b/N_o)_j} \right] \right)$$

Equation (4-12) and (4-13) should give us the same result for N_1 when $N_2=0$. This implies that [3]

$$d\bar{N}_1 = \bar{N}_2$$

Therefore the total number of users is limited by the following constraint [3]

$$\frac{N_1}{\bar{N}_1} + \frac{N_2}{\bar{N}_2} \leq 1 \quad (4-14)$$

Similarly for three classes of user, the constraint will be [3]

$$\frac{N_1}{\bar{N}_1} + \frac{N_2}{\bar{N}_2} + \frac{N_3}{\bar{N}_3} \leq 1 \quad (4-15)$$

Extending to J classes of users, the overall capacity is [3]

$$\sum_{j=1}^J \frac{N_j}{\bar{N}_j} = 1 \quad (4-16)$$

where J is the total number of classes

N_j is the number of users per cell for class j

\bar{N}_j is the number of users per cell which j class can have without the other classes of users

4.3 Handoff Effect on CDMA Capacity for Multiple Classes of Users

In order to compare the effect of hard and soft handoffs on CDMA capacity for multiple classes of users, two simplest cases--hard handoff being performed at the cell boundary and 100% two-way soft handoff are considered. The effect of different bit error rate requirements, different data rates and different activity factors on CDMA capacity is studied. Furthermore, we shall take into account soft handoff region and analyze the capacity for multiple classes of users accordingly. Only two or three classes of users are considered in this section.

4.3.1 CDMA Capacity Comparison with Hard and Soft Handoffs for Multiple Classes of Users

Assume in hard handoff that the mobile communicates with one base station at any given time with hard handoffs being performed at the cell boundary. With 100% two-way soft handoff, the mobile always communicates with two base stations. The other-cell interference factors have been found [5] as $f_{hard}=2.38$ and $f_{soft}=0.77$ when path loss attenuation power $n=4$ and its standard deviation $\sigma=8dB$. Also we assume that the BER requirements can always be satisfied for every class of users, which means the received E_b/N_o is always larger than the required E_b/N_o ($(E_b/N_o)_j > \gamma_j$). Thus the capacity for the j^{th} class of users without the users from the other classes is

$$\bar{N}_j = \frac{1}{1+f} \left(1 + \frac{nG_{pi}}{v_j} \cdot \frac{1}{\gamma_j} \right) \quad (4-17)$$

Perfect power control is assumed as well.

4.3.1.1 Effect of BER requirements on CDMA capacity for multiple classes of users

For a given modulation scheme, when the BER requirements change for different classes of users, the required E_b/N_o for each class of users will change correspondingly. According to equation (4-18), it results in the change of \bar{N}_j which is the number of users that can be supported without other classes of users. Therefore, the number of users for different classes will change accordingly.

Assume that there are two classes of users. The capacity for the class 1 user with hard handoff and 100% soft handoff is estimated according to equation (4-17). The result is shown in Fig 4-1 (In this example there are three class 2 users).

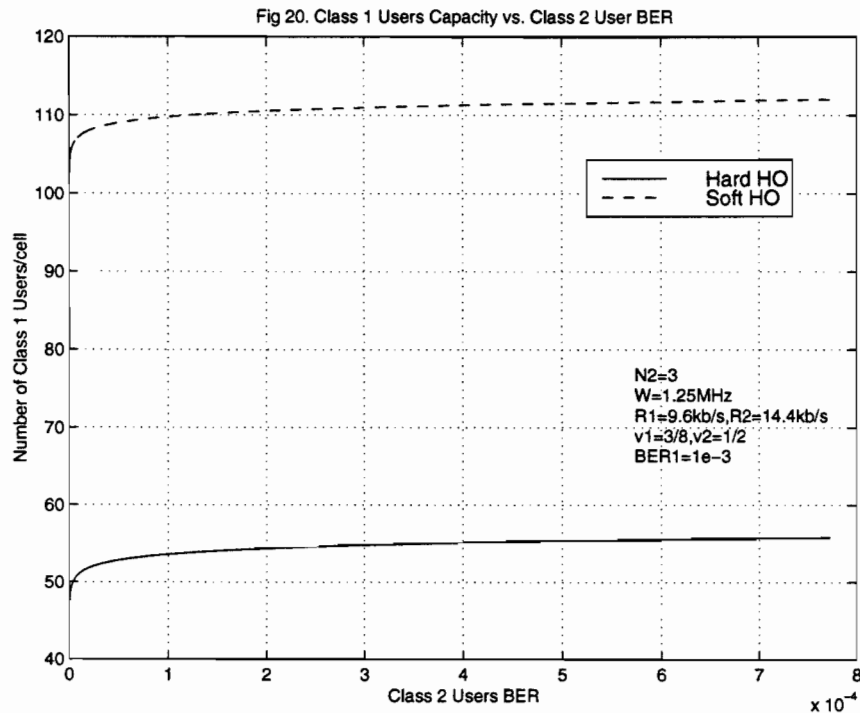

Fig 4-1. Class 1 user capacity vs. Class 2 user BER

In this analysis, we use class 1 users to represent voice users and class 2 users to represent other applications. When the class 2 users' BER changes from 10^{-3} to 10^{-6} , the CDMA capacity changes accordingly. The parameters are chosen as follows:
 total spread bandwidth $W=1.25$ MHz, 10% of the total spectrum which cellular service provider will use to provide service.
 user bit rate $R_1=9.6$ kb/s, $R_2=14.4$ kb/s; standard vocoder data rate.
 activity factor $v_1=3/8$, $v_2=1/2$; assume class 1 users are voice users and class 2 users are some kind of data users.
 required $(E_b/N_o)_1=5(7\text{dB})$; corresponds to $BER_1=10^{-3}$.

When the number of class 2 users are chosen as 0,3,6,9, from hard handoff to 100% soft handoff the increase rate of class 1 user capacity is shown in Fig 4-2. From this graph we can see that when no class 2 users are present ($N_2=0$), the capacity for the class 1 users with soft handoff is approximately 1.9 times of that with hard handoff. It is not affected by class 2 users' BER. When there are more class 2 users present, the capacity increase rate with soft handoff over hard handoff for class 1 users is greater.

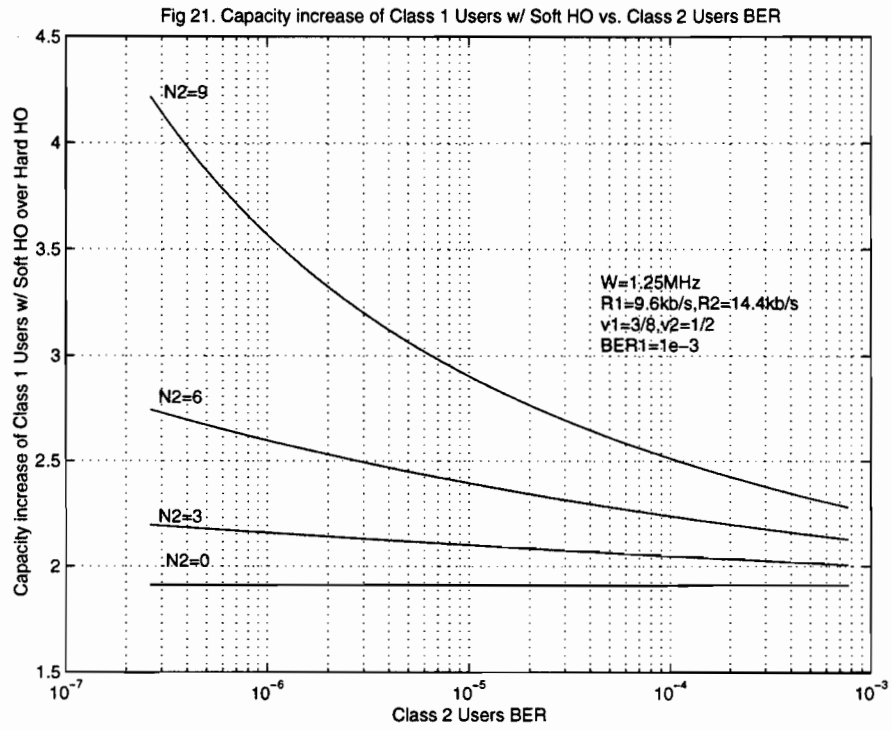

Fig 4-2. Capacity increase of Class 1 user with soft handoff vs. Class 2 user BER

This shows that the more class 2 users we have, the more beneficial it is to use soft handoff. Also, we notice the increment of class 1 user capacity with soft handoff is larger when the BER requirement is higher (e.g. 10^{-6}) for class 2 users. On the other hand, in the hard handoff case the incremental capacity for class 1 users would be smaller.

If there are three classes of users present, the class 1 user capacity is shown in Figure 4-3, assuming variations in the BER requirements for class 2 and class 3 users are (assume there is 1 class 2 user and 1 class 3 user present). The capacity increment for class 1 users from 100% soft handoff to hard handoff is shown in Figure 4-4 as well.

Fig 22. Class 1 Users Capacity vs. Class 2 and 3 Users BER

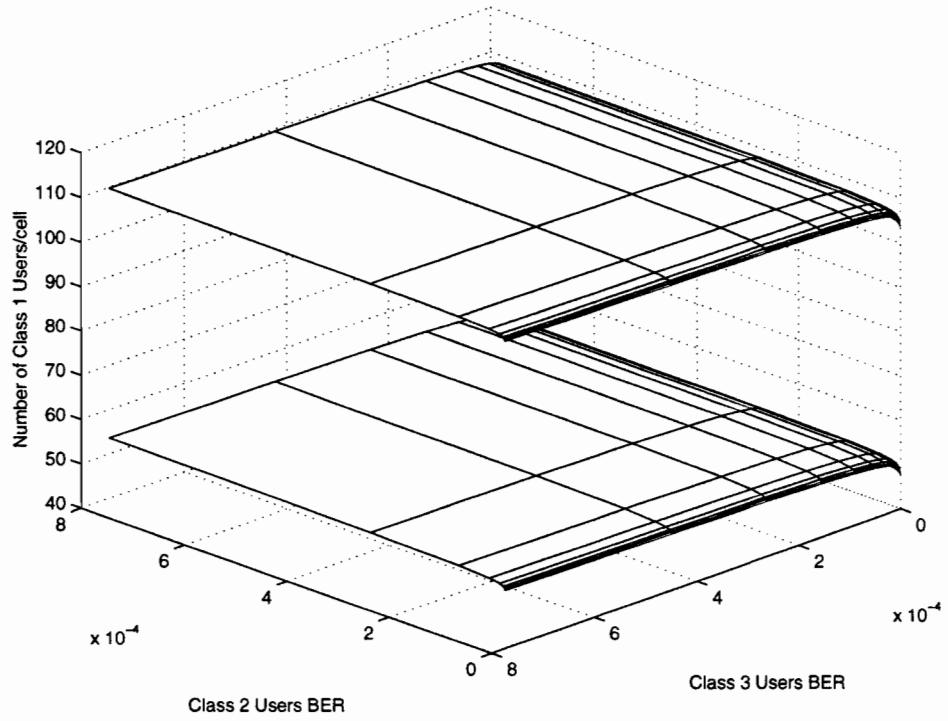

Fig 4-3. Class 1 user capacity vs. Class 2 and Class 3 user BER

Fig 23. Capacity Increase of Class 1 Users w/ Soft HO(N₂=1,N₃=1)

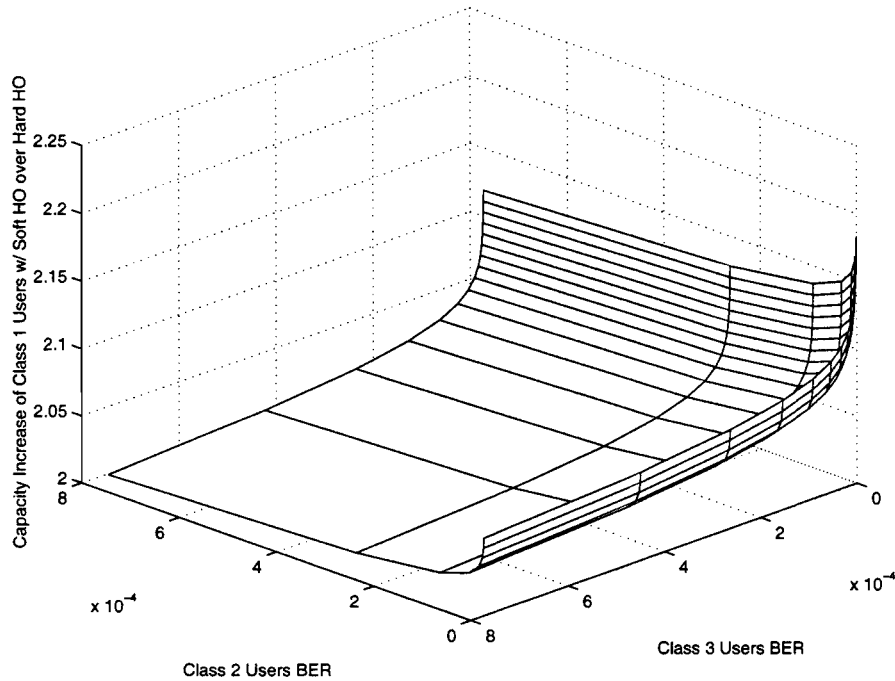

Fig 4-4. Capacity increase of Class 1 user with soft handoff (N₂=1, N₃=1)

From Figure 4-4 we can see when the BER requirements become higher for class 2 and 3 users, the capacity increase rate for class 1 users is greater. This shows that soft handoff is more suitable for a situation with high BER requirements. In this analysis, the parameters are chosen as follows:
 total spread bandwidth $W=1.25$ MHz,
 user bit rate $R_1=9.6$ kb/s, $R_2=14.4$ kb/s, $R_3=28.8$ kb/s;
 activity factor $v_1=3/8$, $v_2=v_3=1/2$,
 required $(E_b/N_o)_1=5(7dB)$ which corresponds to $BER_1=10^{-3}$,

4.3.1.2 Effect of user data rate on CDMA capacity for multiple classes of users

Figure 4-5 shows the capacity of class 1 users with hard and soft handoffs when class 2 users' data rate changes, assuming only two classes of users. We can see that when the data rate of class 2 users increases, the class 1 user capacity decreases to accommodate class 2 users' data rate.

Figure 4-6 shows the capacity increase rate for class 1 users from 100% soft handoff to hard handoff when there are 0,1,2 class 2 users present. As the number of class 2 users increases, the capacity for class 1 users increases more

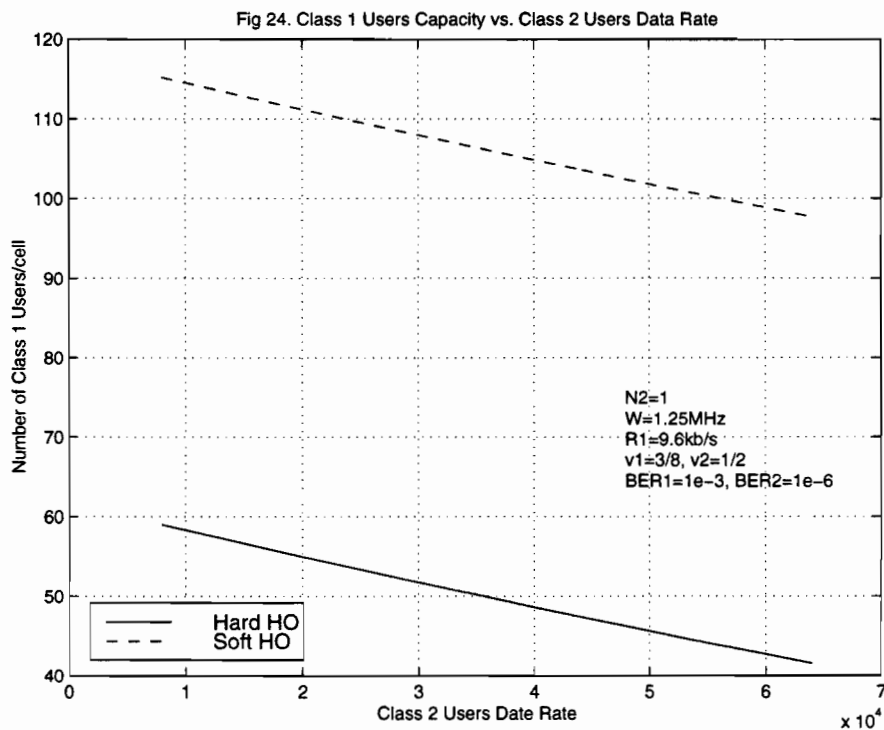

Fig 4-5. Class 1 user capacity vs. Class 2 user data rate

quickly. Also, when class 2 users' data rate increases, we can achieve higher capacity increase rate for class 1 users by using soft handoff.

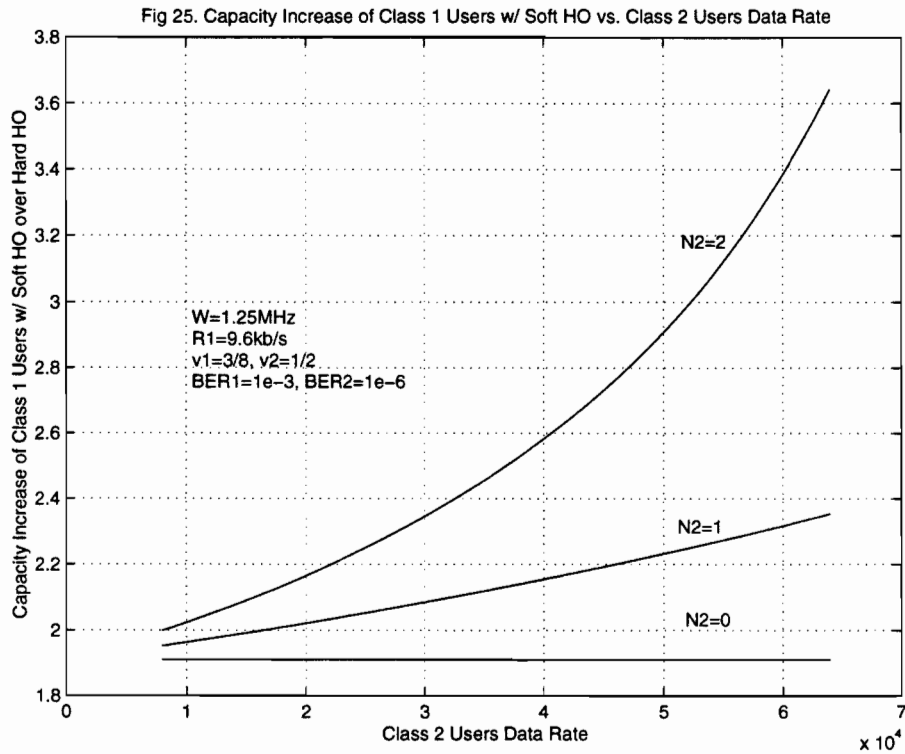

Fig 4-6. Capacity increase of Class 1 user with soft handoff vs. Class 2 user data rate

The parameters used in this analysis are the same as before. For class 2 and 3 users, we assume $BER_2=BER_3=10^{-6}$, resulting in $E_b/N_o=11dB$.

With three classes of users, class 1 user capacity with hard and soft handoffs is shown in Figure 4-7. The capacity increase rate from 100% soft handoff to hard handoff for class 1 users is shown in Figure 4-8.

Fig 26. Class 1 Users Capacity vs. Class 2 and 3 Users Data Rate

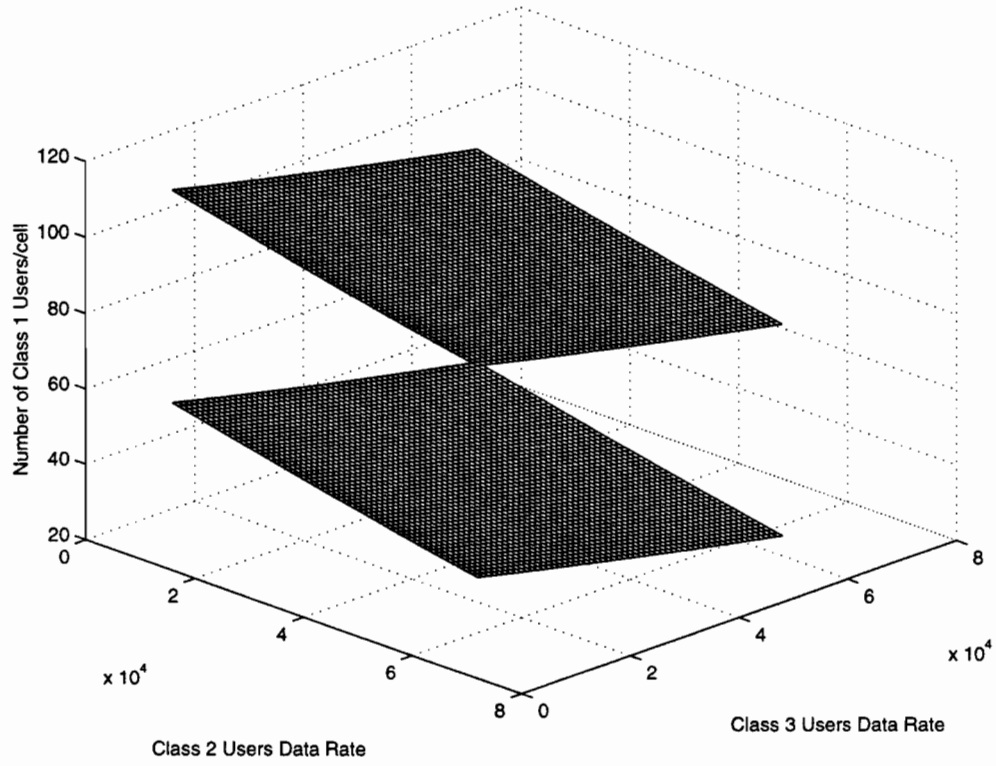

Fig 4-7. Class 1 user capacity vs. Class 2 and Class 3 user data rate

Fig 27. Capacity Increase of Class 1 Users w/ Soft HO($N_2=1, N_3=1$)

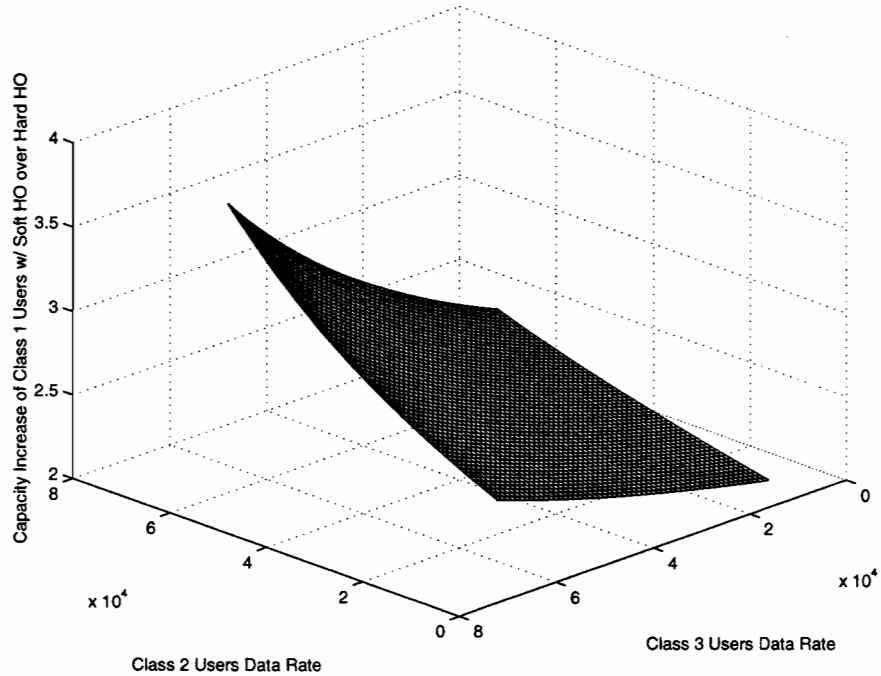

Fig 4-8. Capacity increase of Class 1 user with soft handoff ($N_2=1, N_3=1$)

We can see from these graphs that when the data rates of class 2 and 3 users increase, the capacity of class 1 users decreases to accommodate their high data rate requirements. The capacity increase rate for class 1 users will be higher by using soft handoff when the data rates of class 2 and class 3 users increase.

4.3.1.3 User Activity Factor effect on CDMA capacity for multiple classes of users

The class 1 users are assumed to be voice users, and therefore their voice activity factors are chosen as $v=3/8$. With two classes of users, when the class 2 users' activity factor changes from 0 to 1, the class 1 user capacity decreases as shown in Figure 4-9. The capacity increase rate for class 1 users from hard handoff to soft handoff is shown in Figure 4-10. With three classes of users, the corresponding results are shown in Figure 4-11 and 4-12. From these graphs we observe that when the user activity factors from the other classes increase, the capacity of class 1 users decreases accordingly to accommodate the other class users' high activity. The capacity increase rate of class 1 users also increases. Moreover, we find that when there are more users from other classes present, soft handoff will give us a higher capacity increase rate for class 1 users compared to hard handoff.

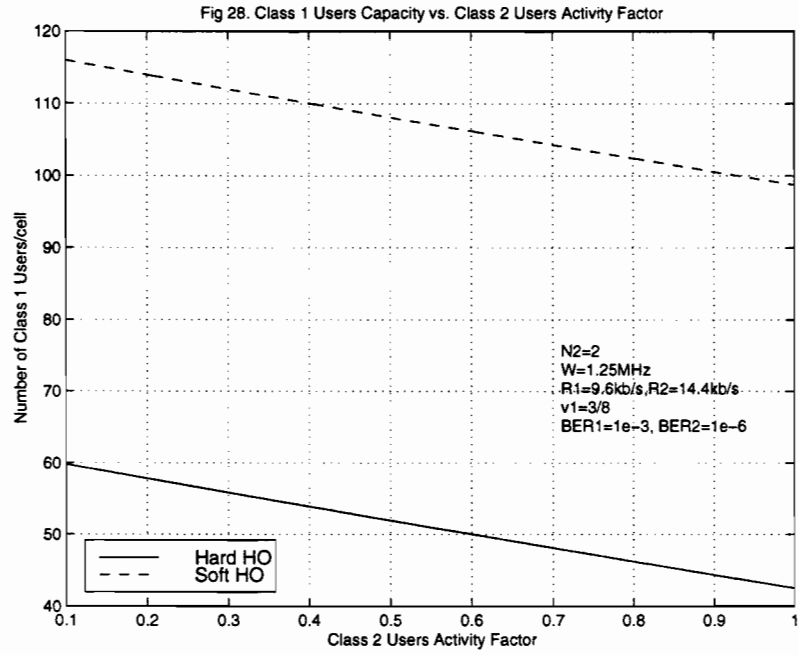

Fig 4-9. Class 1 user capacity vs. Class 2 user activity factor

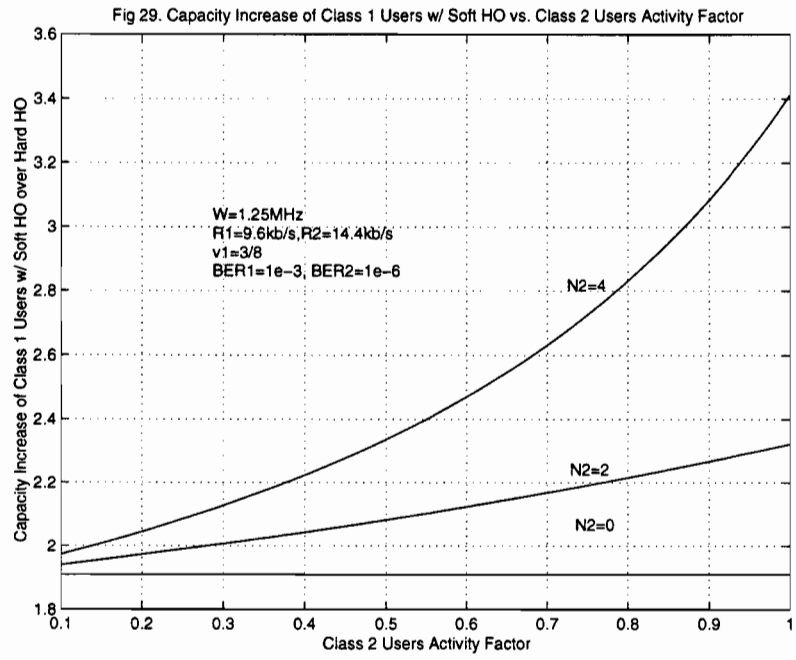

Fig 4-10. Capacity increase of Class 1 user with soft handoff vs. Class 2 user activity factor

Fig 30. Class 1 Users Capacity vs. Class 2 and 3 Users Activity Factor

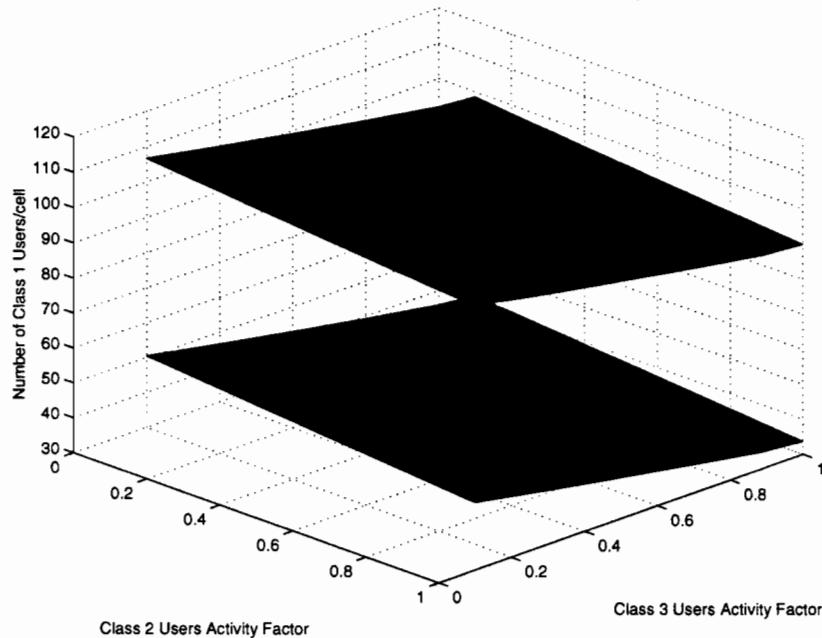

Fig 4-11. Class 1 user capacity vs. Class 2 and Class 3 user activity factor

Generally, when the users from the other classes have higher activity including higher user data rate, higher user activity factor, or higher BER requirements, the capacity of class 1 users will decrease to accommodate the high activity of the other classes' users. Compared to hard handoff, soft handoff offers higher a capacity increase rate for class 1 users as well in these cases. Also, when there are more users from other classes present, soft handoff can accommodate higher capacity increase rate for class 1 users.

4.3.2 Soft Handoff Region Effect on CDMA Capacity

When soft handoff region changes from zero to the full cell size, the other-cell interference factor f will change accordingly as shown in Chapter 3. Since f depends only on the mobile position and not on the user' parameters (e.g. data rate, activity factor), it keeps the same value as in Chapter 3.

Fig 31. Capacity Increase of Class 1 Users w/ Soft HO($N_2=1, N_3=1$)

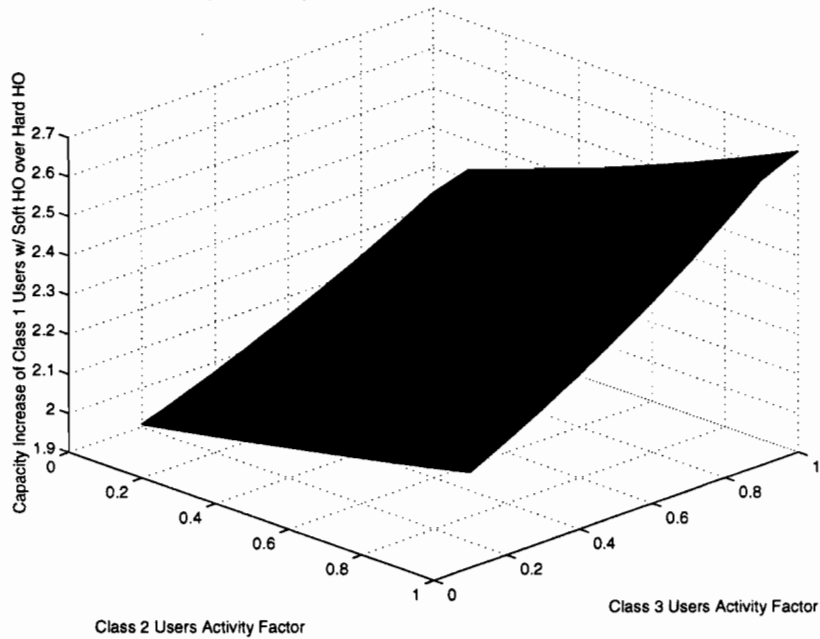

Fig 4-12. Capacity increase of class 1 user with soft handoff ($N_2=1, N_3=1$)

When the soft handoff region changes, Figure 4-13 shows the change of the capacity of class 1 users, with two classes of users. With three classes of users, the result is shown in Figure 4-14. The parameters we used here were chosen to be the same as in the previous analysis. From these two graphs, we observe that after soft handoff region reaches 50%, the capacity for class 1 users reaches its maximum value. The same would happen if we took class 2 or class 3 users as an example. Therefore for multiple classes of users, a CDMA system will have the maximum capacity for every class of users when the soft handoff region reaches approximately 50% of cell size.

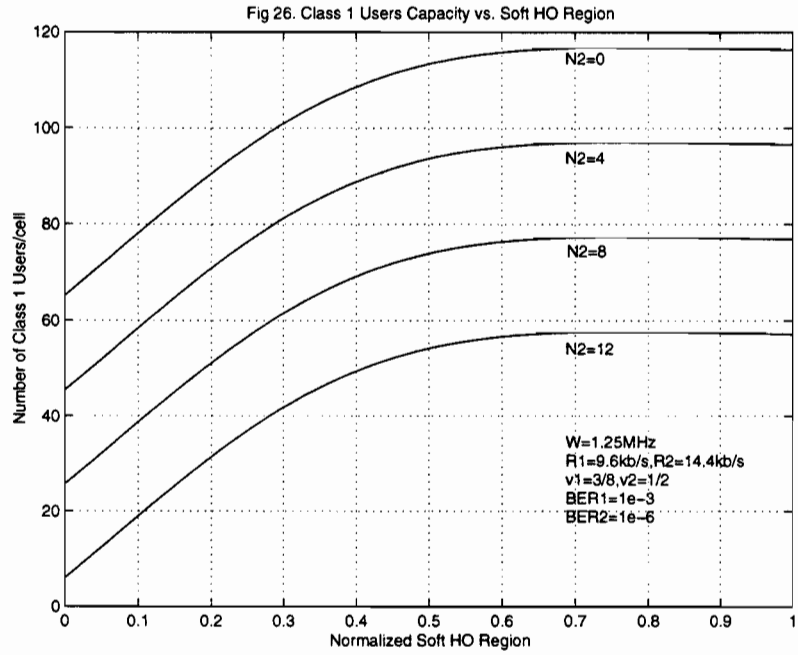

Fig 4-13. Class 1 user capacity vs. soft handoff region (two classes of users)

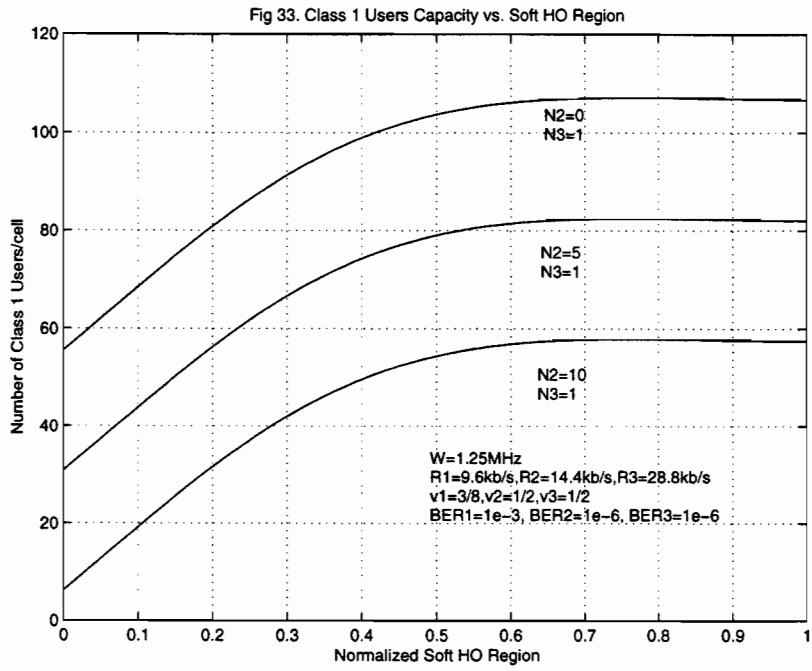

Fig 4-14. Class 1 user capacity vs. soft handoff region (three classes of users)

Chapter 5

Conclusions and Future Work

5.1 Summary of Results

This report has developed the expression of CDMA capacity in terms of number of users per cell with soft handoff for an arbitrary number of user classes, where each class is defined by the bit rate, activity factor, and fidelity requirement. It has been shown that a significant increase in the number of CDMA users can be achieved through the use of soft handoff versus hard handoff.

For one class of users with 100% two-way soft handoff, the number of users per cell is derived as a function of outage probability. With the change of soft handoff area from 100% to 0% of the cell size, the other-cell interference factor is decreased from 2.22 to 0.79. It has been shown in this report that when the soft handoff area is larger than 50% of the cell size, the other-cell interference factor is approximately equal to its minimum value of 0.79. Accordingly, the CDMA capacity reaches its maximum capacity for its region.

For multiple classes of users, the effect of user data rate, user activity factor, bit error rate requirement on CDMA capacity had been studied. It has been shown in this report that when there is a high user "activity" (high user data rate, high user activity factor, low bit error rate requirement for one class of users) the capacity for the other classes of users will be reduced to accommodate this high "activity." The examples have been shown with two classes of users and three classes of users. When the soft handoff area changes from 0% to 100%, the other-cell interference factor changes, and the capacity in terms of number of users per cell for every class changes accordingly. It is also shown that when the soft handoff area is larger than 50% of the cell size, the overall capacity for all of the classes of users approximately equals its maximum value.

In conclusion, we have analyzed the capacity with soft and hard handoff of a multiple classes DS-CDMA cellular system. Also, we have studied the soft handoff area effect on a multi-user DS-CDMA cellular system. Therefore, the results derived in this report can make a significant contribution to the network service provider towards designing a soft handoff scheme for a multi-rate multi-user DS-CDMA.

5.2 Suggestions for Future Work

The main intent of the work done in this report is to analyze the capacity using soft and hard handoff of a wireless channel using DS-CDMA as a multiple access scheme. For one class of users, we have considered the outage probability as a service requirement. For multiple classes of users, we assumed the outage probability is zero. It would be useful to extend this analysis to include non-zero outage probability.

For simplicity, perfect power control is assumed in all cases. In real CDMA systems, power control has a lognormal distribution with variance of 1.5 to 2.5dB. In future work, this could be taken into account to obtain more accurate results.

In this report, we analyzed two-way soft handoff only. It has been shown that 40% of the handoffs in a CDMA system are two-way and 25% are three-way [20]. Three-way and four-way soft handoffs could be taken into account in future work. Also, we could take into account sectorization and analyze softer handoffs to further approximate a "real" system.

Finally, the analysis of the other-cell interference factors vs. soft handoff area could be used in studying the required transmit power of the base station and in further defining soft handoff parameters.

BIBLIOGRAPHY

- [1] K.S. Gilhousen, I.M. Jacobs, R. Padovani, A.J. Viterbi, L.A. Weaver and C.E. Wheatley, "On the Capacity of a Cellular CDMA System," *IEEE Trans. Veh. Technol.*, Vol. 40, No.2, May 1991
- [2] Daniel Wong and Teng Joon Lim, "Soft Handoffs in CDMA Mobile Systems," *IEEE Personal Comm.*, December 1997
- [3] Vijayanand K. Paulrajan, James A. Roberts and D.L. Machamer, "Capacity of a CDMA Cellular System with Variable User Data Rates," in Proc. IEEE GLOBECOM'96, pp. 1458-1462, London, UK, Nov. 18-88, 1996
- [4] A.J. Viterbi, A.M. Viterbi, K.S. Gilhousen, and Ephraim Zehavi, "Soft Handoff extends CDMA Cell Coverage and Increases Reverse Link Capacity," *IEEE J. Select. Areas Commun.*, Vol.12, No.8, October 1994
- [5] A.J. Viterbi, A.M. Viterbi and Ephraim Zehavi, "Other-Cell Interference in Cellular Power-Controlled CDMA," *IEEE Trans. On Comm.*, Vol. 42, No.2/3/4, February/March/April 1994
- [6] Pulin R. Patel, Usman S. Goni, Eric Miller and Paul P.S.Carter, "A simple analysis of CDMA Soft Handoff Gain and Its Effect on the Cell's Coverage Area," *Wireless information networks: architecture, resource management, and mobile data*, No. 351, 1996
- [7] DongSeung KWON, EungSoon SHIN, JaeHeung KIM, and InMyoung JEONG, "Effect of Path Loss and Cell Loading on Frequency Reuse Efficiency and Soft Handoff in CDMA System," *IEICE Trans. Fundamentals*. Vol. E79-A, No. 6, June 1996
- [8] A.M. Viterbi and A.J. Viterbi, "Erlang Capacity of a Power Controlled CDMA System," *IEEE Journal On Selected Areas in Comm*. Vol. 11, No. 6, August 1993
- [9] W.C.Y. Lee, "Overview of Cellular CDMA," *IEEE Trans. Veh. Technol.*, Vol. 40, pp. 291-302, May 1991
- [10] Chin-Chun Lee and Raymond Steele, "Effect of Soft and Softer Handoffs on CDMA System Capacity," *IEEE Trans. Veh. Technol.*, Vol. 47, No.3, August 1998
- [11] Vijay K. Gary, Kenneth F. Smolik and Joseph E. Wilkes, "Applications of CDMA in Wireless/Personal Communications," Prentice Hall, Upper Saddle River, NJ, 1997
- [12] Stephen S. Rappaport and Cezary Purzynski, "Prioritized Resource Assignment for Mobile Cellular Communication Systems with Mixed Services and Platform Types," *IEEE Trans. Veh. Technol*, Vol.45, No.3, August 1996
- [13] Michele Zorzi and Silvano Pupolin, "Outage Probability in Multiple Access Packet Radio Networks in the Presence of Fading," *IEEE Trans. Veh. Technol.*, Vol.43, No.3, August 1994
- [14] Jialin Zou and Vijay K. Bhargava, "On Soft Handoff, Erlang Capacity and Service Quality of a CDMA Cellular System: Reverse Link Analysis," Dept. of Computer and Electrical Engineering, Univ. of Victoria

- [15] Szu-Lin Su, Jen-Yeu Chen and Jane-Hwa Huang, "Performance Analysis of Soft Handoff in CDMA Cellular Networks," *IEEE Journal On Selected Areas in Comm.*, Vol.14, No.9, December 1996
- [16] Kyoung Il Kim, "CDMA Cellular Engineering Issues," *IEEE Trans. Veh. Technol.* Vol.42, No.3, August 1993
- [17] Seon-Ho Hwang, Seong-Lyun Kim, Hyun-Seo Oh, Chang-Eon Kang and Jung-Young Son, "Soft Handoff Algorithm with Variable Thresholds in CDMA Cellular Systems," *Electronics Letters*, Vol.33, No.19, September 1997
- [18] David J. Goodman, "*Wireless Personal Communications Systems*," Addison-Wesley, 1997
- [19] A.J. Viterbi, "*CDMA---Principles of Spread Spectrum Communication*," Reading, Mass.: Addison-Wesley Pub. Co., c1995
- [20] Savo Glisic and Branka Vucetic, "Spread Spectrum CDMA Systems for Wireless Communications," *Mobile Communications Series*, 1997
- [21] J. A. Roberts and T. J. Healy, "Packet Radio Performance over Slow Rayleigh Fading Channels," *IEEE Trans. On Comm.*, Vol. COM-28, pp. 279-286, Feb.1980
- [22] John G. Proakis, "*Digital Communications*," New York: McGraw-Hill, Inc., c1995
- [23] T. S. Rappaport, "*Wireless Communications*," Upper Saddle River, N.J.: Prentice-Hall, Inc., c1996
- [24] TIA/EIA IS-95, "*Mobile Station-Base Station Compatibility Standard for Dual-Mode Wideband Spread Spectrum Cellular System*."
- [25] J. A. Roberts, "*EECS 865 Class Notes*," University of Kansas, 1997
- [26] Yoshihiko Asano, Y. Daido and J. M. Holtzman, "Performance Evaluation for Band-Limited DS-CDMA Communication System," *IEEE Trans. Veh. Technol.*, pp. 464-468, 1993
- [26] R. Prasad, "*CDMA for Wireless Personal Communications*," Mobile Communication Series, Artech House Publishers, London
- [27] W. C. Y. Lee, "*Mobile Communications Design Fundamentals*," New York: Howard W. Sams & Co., c1995
- [28] M. K. Simon, Omura, R. A. Scholtz and B. K. Levitt, "*Spread Spectrum Communications*," Computer Science Press, Rockville, Maryland