

A Subnanosecond Polarization-Independent Tunable Filter/Wavelength Router Using a Sagnac Interferometer

Xiaojun Fang, *Senior Member, IEEE*, Kenneth Demarest, *Member, IEEE*, Helin Ji, Christopher Allen, *Senior Member, IEEE*, and Lawrence Pelz, *Member, IEEE*

Abstract—A high-speed, polarization independent, electrooptic tunable filter was built using a birefringence modulator within a Sagnac interferometer. Switching times less than 0.5 ns were achieved in our experiment for this filter. Application in high-speed wavelength routing was also demonstrated.

Index Terms—Communication system routing, filter, optical fibers, polarization.

WAVELENGTH-DIVISION multiplexing (WDM) technology increases the capacity of fiber telecommunication systems by orders of magnitude and is rapidly being deployed in broadband fiber backbone networks. Because of this new dimension of multiple wavelengths, network management and channel (wavelength) routing using optical technology has become an important research issue. Active wavelength routing and wavelength conversion can establish a wavelength or virtual wavelength path within an optical fiber network, which is especially useful for data trunk transmission [1]. Currently, available techniques for tunable filters include acoustooptic modulators [2], Fabry–Perot filters [3], and unbalanced Mach–Zehnder (MZ) interferometer [4]. Of these, the Pockels effect-based devices have the highest speed. However, because the Pockels effect involves birefringence, filters based on MZ interferometer usually have a strong input polarization dependence. Also, since the MZ interferometer is unbalanced, it is also temperature dependent. Furthermore, higher-order filters are possible only by cascading several unbalanced MZ interferometers.

Sagnac interferometer-based filters, on the other hand, are polarization independent [5]. In previous publication we showed that most types of filter transfer functions can be realized using a single Sagnac interferometer simply by selecting a proper loop birefringence [6]. In this letter, we use a high-speed birefringence modulator to modulate the loop birefringence, thereby obtaining a polarization independent tunable filter which can be used for wavelength routing.

Manuscript received June 26, 1997; revised July 22, 1997.
X. Fang is with Sprint Advanced Technology Laboratories, Burlingame, CA 94010 USA.

K. Demarest, H. Ji, and C. Allen are with the Information and Telecommunication Technology Center, Department of Electrical Engineering and Computer Sciences, University of Kansas, Lawrence, KS 66045 USA.

L. Pelz is with Sprint, Overland Park, KS 66212 USA.
Publisher Item Identifier S 1041-1135(97)07943-3.

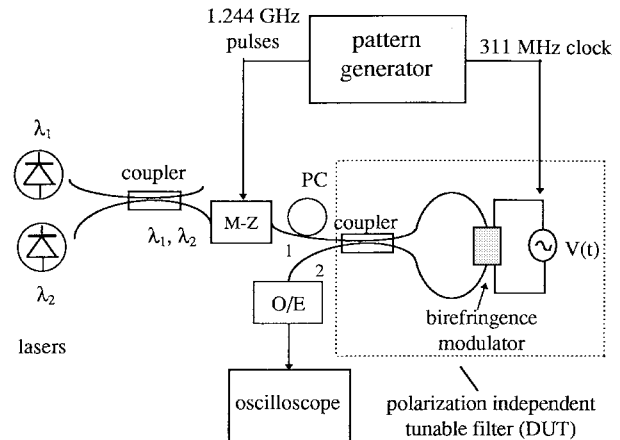

Fig. 1. Structure of a polarization independent tunable filter and experiment setup for wavelength routing.

If we assume a general form for the input light field to a Sagnac interferometer to be

$$E_{\text{in}} = \begin{bmatrix} E_x \\ E_y \end{bmatrix} \quad (1)$$

then the output light field from a Sagnac interferometer will be [5]

$$E_{\text{out}} = i\text{Im}(B) \begin{bmatrix} E_y \\ E_x \end{bmatrix} \quad (2)$$

where $\text{Im}(B)$ represents the imaginary part of B , where B is the off-diagonal term of the Jones matrix representing the loop birefringence of the Sagnac interferometer. The intensity transfer function of the birefringent Sagnac interferometer is thus given by

$$T = (\text{Im}(B))^2. \quad (3)$$

It is important to note from (3) that the intensity transfer function is independent of the input polarization state (1). The Sagnac interferometer splits the input light between transmission and reflection paths according to loop birefringence. If a polarization independent circulator or a coupler is placed in front of the input port of the Sagnac interferometer to lead the reflection light out, a polarization independent 1×2 splitter can be realized with intensity transfer function to the two output ports to be T and $1 - T$, respectively.

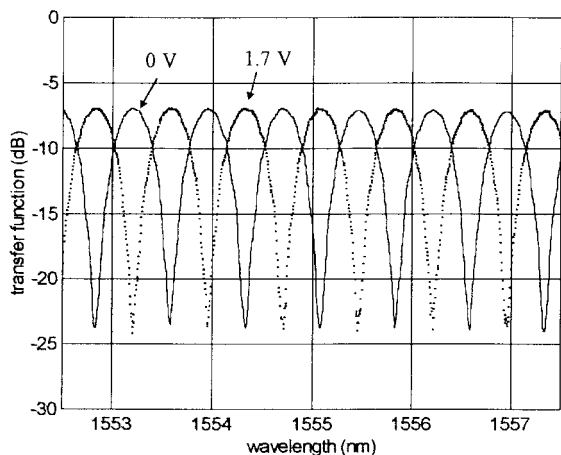

Fig. 2. Wavelength selective characteristic of the tunable filter. Solid line is for $V = 0$ V and dotted line is for $V = 1.7$ V.

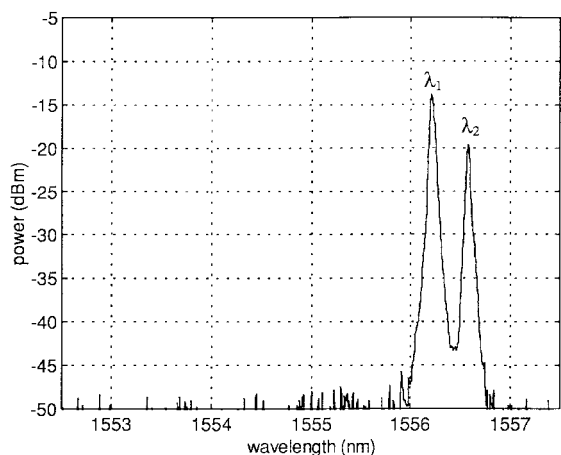

Fig. 3. Output spectrum of the two lasers.

Next, an active birefringence modulator is placed in the middle of the Sagnac interferometer with its principal axes along the 45° direction relative to the plane defined by the Sagnac loop. Because the birefringence modulator is lithium–niobate-based device and can be modeled as a linear birefringence, the transfer function of such configured Sagnac interferometer will be

$$T = \sin^2 \left(\frac{\phi_0 + \Delta\phi(V)}{2} \right) \quad (4)$$

where ϕ_0 is the phase retardation of the initial linear birefringence of the birefringence modulator, and $\Delta\phi(V)$ is the change of phase retardation induced by the drive voltage V . Because $\phi_0 + \Delta\phi(V)$ is wavelength dependent, the transfer function T is wavelength dependent also and transmission coefficient of a certain wavelength can be controlled by the external drive voltage V . The larger the initial birefringence ϕ_0 chosen, the smaller the spectral period of the device will be.

A tunable filter was built with a 3-GHz birefringence modulator and an ordinary 3-dB fiber coupler as shown in Fig. 1. The birefringence modulator was in the center of the loop. First, broadband unpolarized light from an Er-doped fiber amplifier was fed into the filter and an optical spectrum

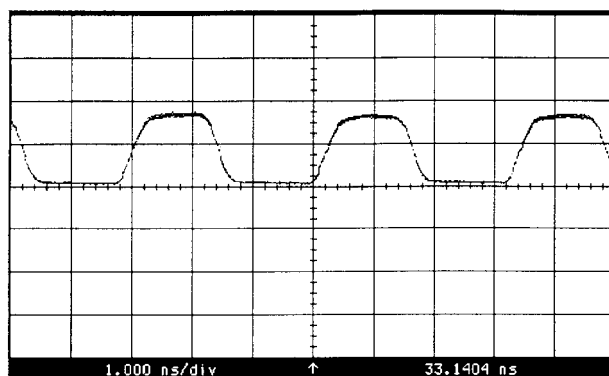

(a)

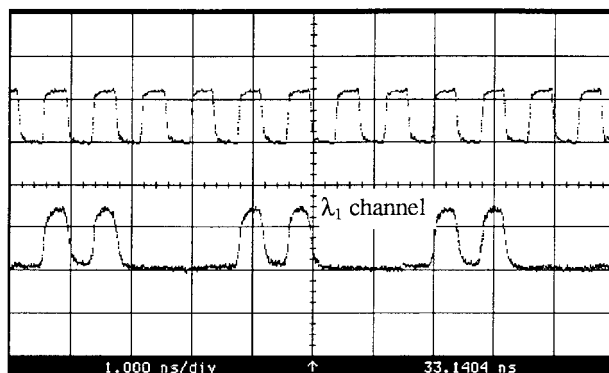

(b)

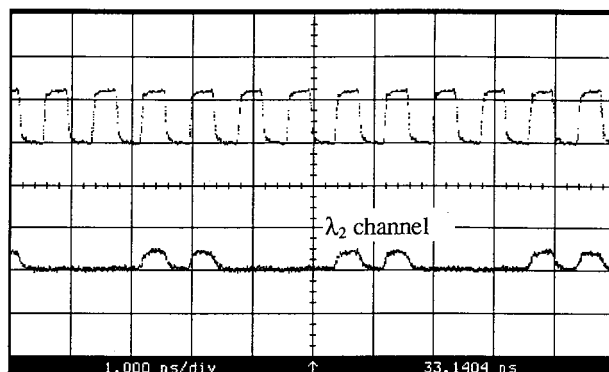

(c)

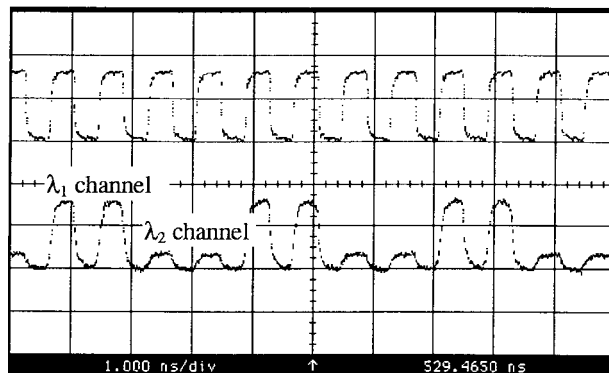

(d)

Fig. 4. (a) Time response of the of the device driven by a 311-MHz clock signal. (b) Switched output pulses of wavelength λ_1 . The upper trace is the electrical drive signal exerted on the MZ modulator. (c) Switched output pulses of wavelength λ_2 . (d) Switched output signal of the device when both lasers were on.

analyzer (OSA) was used to measure the intensity transfer function. The output spectrum measured on the OSA is shown in Fig. 2, where the solid line is the spectrum for $V = 0$ volt and the dotted line is the spectrum for $V = 1.7$ volt. Fig. 2 demonstrates that signals of a particular wavelength can be switched between transmission and reflection paths by changing the external drive voltage, where the bandwidth of the OSA was chosen to be 5 nm with 0.05-nm resolution. Although the switching voltage V_{π} for our modulator was only about 1.7 volts for dc voltage, it increased to about 7 V at 1 GHz. The splitting ratio of the coupler away from 3 dB will decrease extinction ratio of the switch, similar as in an MZ modulator.

A second experiment involved high speed wavelength switching, as shown in Fig. 1. Two continuous-wave (CW) light sources were a DFB laser and a tunable laser. A polarization controller was used to change input polarization state to test the polarization dependence of the device. An MZ modulator was used to encode a 1.244 Gb/s return-to-zero bit sequence generated by a pattern generator onto the light signal. Two lasers with different wavelengths were used and their spectra are shown in Fig. 3. The intensities of the two lasers were intentionally set to be different to serve as a wavelength indicator. First, the switching response of the tunable filter was measured by directly connecting it to one laser. The drive voltage was provided by the 311 MHz trigger signal of the pattern generator. The output optical signal was recorded by a digital oscilloscope and is shown in Fig. 4(a). The switching time is determined by the rise and fall times which are about 0.5 ns, and it is believed that faster switching time can be achieved by using higher bandwidth birefringence modulators and microwave amplifiers.

Wavelength routing was tested by passing the encoded optical pulses of different wavelengths into the device. Fig. 4(b) shows the output of the periodically switched filter for λ_1 input. The upper trace is the electrical drive signal applied to the MZ intensity modulator that breaks the input CW light into similar pulse waveform. It is clearly seen that the pulses of wavelength λ_1 were switched between the transmission and reflection paths every two pulse periods by the 311-MHz switch signal. Similarly, when λ_1 was turned off and λ_2 was

turned on the result for switched bit sequence is shown in Fig. 4(c). Because the spacing between the two wavelengths were selected to be half the period of the filter (see Figs. 2 and 3), the control voltage for which the λ_1 channel was switched to the transmission path would switch the λ_2 channel to the reflection path. This can be seen by comparing Fig. 4(b) to (c). Hence, at any time, only one wavelength channel is transmitted while the other is reflected. Finally, both lasers were turned on, pulse sequences of the two wavelength channels were separated and routed between the transmission port and the reflection port alternatively every two pulse periods. Only the transmission port output was measured and the result is shown in Fig. 4(d). The two wavelength channels were demultiplexed and routed alternatively between the two ports. Polarization dependence of this device was tested by adjusting the input polarization state through a polarization controller; no noticeable changes were observed.

In conclusion, a Sagnac interferometer-based polarization independent high-speed electrooptic tunable filter is presented. A switching time of about 0.5 ns was achieved using a 3-GHz birefringence modulator. Higher order polarization insensitive tunable filters or adaptive filters are possible which could be more compact in structure than those achieved by cascading MZ interferometers.

REFERENCES

- [1] J. Y. Hui and K. W. Cheung, "Optical versus electrical switching for broadband networks," *IEEE Network*, vol. 10, no. 6, pp. 21–25, 1996.
- [2] D. A. Smith, J. E. Baran, J. J. Johnson, and K. Cheung, "Integrated-optic acoustically-tunable filters for WDM networks," *IEEE J. Select. Areas Commun.*, vol. 8, p. 1151, 1990.
- [3] J. Stone and L. W. Stulz, "Pigtailed high-finesse tunable fiber Fabry-Perot interferometer with large, medium, and small free spectral ranges," *Electron. Lett.*, vol. 23, pp. 781–783, 1987.
- [4] E. L. Wooten, R. L. Stone, E. W. Miles, and E. M. Bradley, "Rapidly tunable narrowband wavelength filter using LiNbO₃ unbalanced Mach-Zehnder interferometers," *J. Lightwave Technol.*, vol. 14, pp. 2530–2536, 1996.
- [5] X. Fang and R. O. Claus, "Polarization-independent all-fiber wavelength-division multiplexer based on a Sagnac interferometer," *Opt. Lett.*, vol. 20, pp. 2146–2148, 1995.
- [6] X. Fang, H. Ji, C. Allen, K. Demarest, and L. Pelz, "A compound high order polarization-independent birefringence filter based on Sagnac interferometers," *IEEE Photon. Technol. Lett.*, vol. 9, pp. 458–460, Apr. 1997.