

Technical Report

## **Analysis of Measured ATM Traffic on OC Links**

Sarat Chandrika Pothuri, Logeshwaran Vijayan,  
and David W. Petr

ITTC-FY2001-TR-18838-01

March 2001

Project Sponsor:  
Sprint Corporation

# CONTENTS

<b>ABSTRACT .....</b>	<b>2</b>
<b>INTRODUCTION:.....</b>	<b>3</b>
<b>DATA: .....</b>	<b>5</b>
Data Reference Table: .....	6
<b>STUDY OF SELF-SIMILARITY:.....</b>	<b>8</b>
Peak Rate Vs logarithm of Averaging Interval: .....	9
Comparison with exponentially distributed data: .....	10
Peak rate for the expansion of timescales: .....	11
<b>PEAK RATE OF LINKS:.....</b>	<b>16</b>
OC-3 link: .....	17
OC-12 link: .....	18
Ratio of maximum to minimum peak rates of the links. ....	18
<b>PEAK RATE OF A VC/VP: .....</b>	<b>19</b>
Peak rate of a single VC/VP: .....	20
Ratio of maximum to minimum peak rate of VCC's : .....	21
Comparison of peak rates in OC-links and its VCCs: .....	23
<b>FUTURE WORK : .....</b>	<b>24</b>
<b>CONCLUSIONS: .....</b>	<b>25</b>
<b>APPENDIX .....</b>	<b>26</b>

## **Abstract**

The ATM cell-count data for several Sprint switch ports is analyzed to obtain the peak rate of various Virtual Circuit /Virtual Path pairs and optical fiber links. With 5 ms and 10 ms measurement period between the cell counts on different links, the data is shown to exhibit self-similarity. It is also shown that the peak rate at a higher aggregation time interval is lower than the peak rate at a lower aggregation time interval. Variation of peak rate as a function of aggregation interval in VCCs and OC-links is analyzed leading to an observation of typical behavior of VCCs in one of the links. This peak rate study that is performed on both OC-3 and OC-12 links helps in providing a unified approach to the understanding of the behavior of cell traffic during the busy periods. Analysis is also done on the ratio of maximum to minimum peak rate and the equations describing the behavior of traffic in VCCs on both OC-3 and OC-12 links. The nature of traffic throughout the measurement period of three days is captured in the ratio plots. Study on the peak rate of a VC on all the links was done to observe the traffic pattern of it in both types of OC links. Similar traffic patterns in VCCs were observed on OC links and with this knowledge of similarity in traffic and the ratio of the minimum and maximum peak rates, equations to calculate the approximate maximum peak rate are described. Future work is to explore the similarity in traffic in VCCs and OC links and to build an appropriate mathematical model for this traffic.

## Introduction:

ATM traffic data is analyzed to determine its peak rate behavior as a function of aggregation time ranging from 5 ms to one hour. We illustrate the self-similar tendencies of the traffic data by comparing with the synthetic data that is independent and exponentially distributed.

ATM is a high-speed connection-oriented network technology that sends data through switched and permanent virtual circuits. A fundamental concept of ATM is that switching occurs based upon the VPI/VCI (Virtual Path Identifier/Virtual Channel Identifier) fields of each cell (fixed-size ATM packet). Switching done on the VPI only is called Virtual Path Connection (VPC), while switching done on both the VPI/VCI values is called Virtual Channel Connection (VCC). VCCs between the same two points along a network path are grouped into a Virtual Path Connection (VPC). VPCs are multiplexed onto transmission links. Fig.0 shows how the switching is done for VPs and VCs. The communications over an ATM Layer connection may be either bi-directional or unidirectional. The same Virtual Channel Identifier (VCI) is used for both directions of a connection at an interface. ATM is capable of operating at bit rates of 155.52 (OC3) and 622.08 (OC12) Mb/s. Both OC-3 and OC-12 links that are included in the study are bi-directional and the data is analyzed at each uni-directional port on the link.

Sprint personnel collected cell-count data on a per-VCC basis for several switch ports. Details of the data collection are given in the next section. Also, the basic definitions used in this report are as follows:

*Time Interval:* A particular non-overlapping time slot in seconds.

Each VC or link data set is divided into intervals (time slots) of integral multiples of 5 milliseconds.

*Aggregation Interval:* The time slot that is an integral multiple of 5 ms.

For example, a 1-second aggregation interval consists of 200 consecutive 5 ms intervals

*Cell Count:* Number of cells in a particular aggregated interval.

*Peak Count:* The maximum cell count among the cell counts in the similar aggregation intervals. For example, the maximum cell-count among all 1-second intervals

*Peak Rate:* the peak count for a particular interval converted into Mb/s rate.

Each peak count is transformed into peak rate by the conversion factor  $(53 \cdot 8) / \text{length of aggregation interval}$  where 53 is the length of the cell (in bytes) and 8 is the number of bits (one byte).

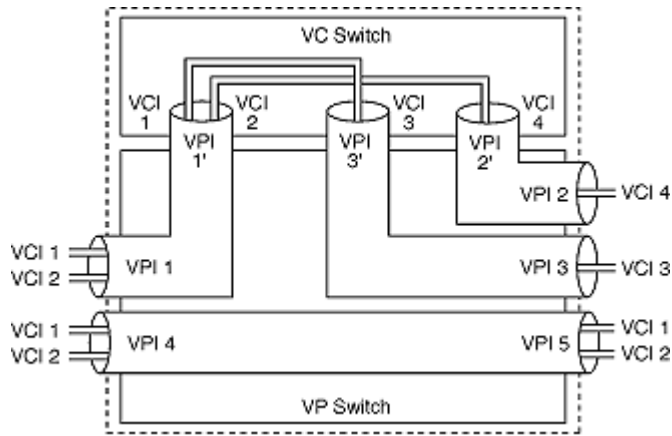

Fig.0

The primary studies done on the data are:

- Generate independent exponential data for a single VCC to compare with the actual data of that VCC to study its characteristics.
- Obtain the occurrence of peak rate in the 5 ms, one-second, one-minute and one-hour aggregation of data for a particular VCC that demonstrates the self-similar behavior of the traffic.
- Find the peak rate as a function of aggregation interval of individual connections at different switches on different links and compare the results. Also find the ratio of maximum to minimum peak rates.
- Find the peak rate versus aggregation interval for each link and the ratio of maximum to minimum peak rate for each link.
- Find equations describing the peak rate of the OC and individual VCC traffic.
- Find relationships between ratio of maximum to minimum peak rate and hourly (minimum) peak rate for VCCs on all the links and for the links themselves.

The plots in the Appendix show the peak rate (Mb/s) versus the length of aggregation interval (seconds) of all the OC links, similar plots for a single VCC in different directions and on different days, and the ratio of maximum to minimum peak rate versus the hourly peak rate. Other plots are given and discussed in the body of the report.

## Data:

In this report, analysis is done on traffic data collected over 24-hour periods from OC-3 links and OC-12 links on 3 consecutive days. The following table shows the date on which data was collected and the notation used in this report.

Notation	Date
Day 1	January 24, 2000 (12.01 p.m.) to January 25, 2000 (12.00 p.m.)
Day 2	January 25, 2000 (12.01 p.m.) to January 26, 2000(12.00 p.m.)
Day 3	January 26, 2000 (12.01 p.m.) to January 27, 2000(12.00 p.m.)

OC-3 data set consists of data collected over 24 hours on days 1 through 3 on a single switch with port number 1D1. OC-12 test set includes data tracked on switch with port number 3C2 for 2 days with duration of 3 hours on day 1 and 24 hours on day 2. OC-12 data was also collected on switch with port number 1A4 with a basic measurement period of 10 ms on day 3. The following sections refer to data on nine links which should be understood as data on different days on different links. The information about the data collection on various links can be expanded from Table 2 . Port-out and port-in refer to the same port but the data is collected in opposite directions.

The ATM data was obtained on per VC/VP basis by a bi-directional switch with the basic measurement period of 5 ms from Sprint Corp. The links being bi-directional, data was captured on the same switch at different ports in different directions.

Day 3 data seems to be unexpected and strange in terms of bursts in the VCs, which can be observed from Table 1 on the next page. Table 1 consists of cell counts with a measurement period of 5 ms on Day 3 of a few VCs on the OC-3 link. There is a periodic trend in the occurrence of bursts in each VC with a period of approximately 150ms between the bursts. The VCs are correlated in the sense that there is a lag of about 5ms in the occurrence of bursts in the successive VCs. Successive VCs in this context refers to the ordering of the VCs while recording the data. This unusual behavior is also evidenced in the analysis on the data later in the report but this atypical nature of traffic is unexpected and is to be explored.

Figure 1 on the next page clearly indicates the periodic trend in occurrence of bursts in the VCs. We can say that VCs are correlated in terms of similarity in the burst occurrence and the length of the burst, which is approximately the same in all the VCs. This pattern was repeated in all the VCs throughout Day 3.

0	7	0	0	0	0	0	0	0
0	10	36	15	0	0	0	0	0
0	0	25	0	7	2	0	0	0
0	0	0	11	17	0	0	5	0
0	0	0	0	22	29	25	3	3
0	0	0	0	0	41	7	6	3
0	0	0	0	0	0	11	2	2
0	0	0	0	0	0	0	2	0
0	0	0	0	0	0	0	0	4
0	0	0	0	0	0	0	0	0
0	0	0	0	0	0	0	0	0
0	0	0	0	0	0	0	0	0
0	0	0	0	0	0	0	0	0
0	0	0	0	0	0	0	0	0
0	0	0	0	0	0	0	0	0
0	0	0	0	0	0	0	0	0
0	0	0	0	0	0	0	0	0
0	0	0	0	0	0	0	0	0
0	0	0	0	0	0	0	0	0
0	0	0	0	0	0	0	0	0
0	0	0	0	0	0	0	0	0
0	0	0	0	0	0	0	0	0
0	0	0	0	0	0	0	0	0
0	0	0	0	0	0	0	0	0
0	0	0	0	0	0	0	0	0
0	0	0	0	0	0	0	0	0
0	0	0	0	0	0	0	0	0
2	3	0	0	0	0	0	0	0
0	4	0	0	0	0	0	0	0
0	0	4	0	0	0	0	0	0
9	0	0	2	0	0	10	0	0
0	0	0	0	4	0	0	0	0
0	0	0	0	0	0	0	0	3
0	0	40	0	2	0	2	0	0
16	0	0	2	0	0	0	4	6
0	9	0	4	9	0	0	0	2
46	0	32	2	0	0	0	5	0

Table 1 : Cell counts on VCs for Day 3

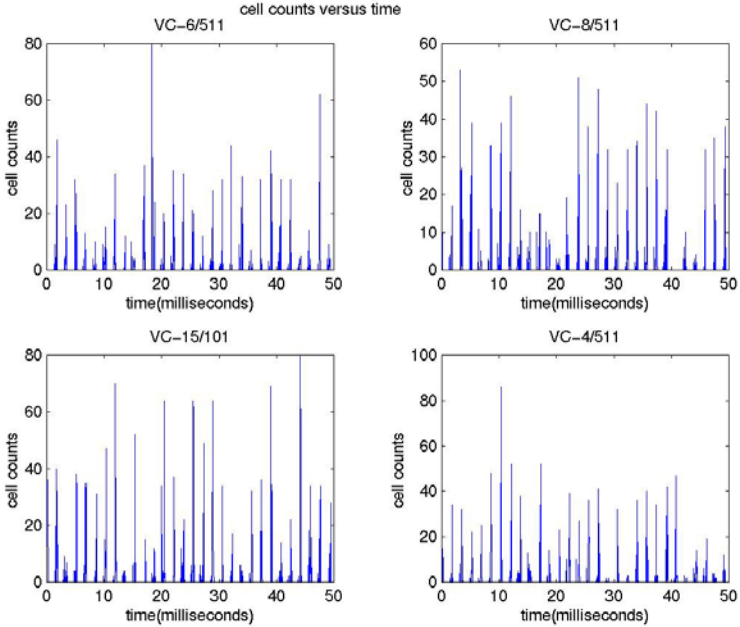

Figure 1. Cell Counts for Day 3

## Data Reference Table:

The table below gives the basic idea of the data collected, type of port and link and also the maximum and minimum peak rate of the **link**.

Z is the short notation used for KSCYMOECBB

Switch Name	Date	Port	In/ Out	Link (OC)	Figure no./ Notation	Maximum Peak rate(M) ( Mb/s)	Minimum Peak rate(N) ( Mb/s)	Ratio M/N	#VC
Z4-1D1	1/24/00 ,12pm – 1/25/00, 12.30pm	Port -Out		3	13 , oc3link1	60.8	13.70	5	37
Z4-1D1	1/25/00 ,2pm – 1/26/00, 2.25pm	Port –in		3	21, oc3link2	41.2	4.89	9	37
Z4-1D1	1/26/00, 3 p.m – 1/27/00, 3 p.m.	Port –in		3	22, oc3link3	32.7	5.67	6	33
Z4-3C2	1/24/00 ,12pm – 1/24/00, 3.02pm	Port –in		12	23, oc12link1	174.1	11.42	15	41
Z4-3C2	1/24/00 ,12pm – 1/24/00, 3.02pm	Port –out		12	24, oc12link2	184.6	13.4	14	39
Z4-3C2	1/25/00 ,2pm – 1/26/00, 2.25pm	Port –in		12	25, oc12link3	171.72	9.56	18	37
Z4-3C2	1/25/00 ,2pm – 1/26/00, 2.25pm	Port –out		12	26, oc12link4	179.52	14.02	13	36
Z4-1A4	1/26/00 ,4pm – 1/27/00, 4.05pm	Port –in		12	27, oc12link5	168.62	8.7	19	57
Z4-1A4	1/26/00 ,4pm – 1/27/00, 4.05pm	Port –out		12	28, oc12link6	187.13	21.0	9	64

Table 2



## Study of self-similarity:

Traffic that is bursty on many or all time scales can be described with the property of self-similarity. Self-similarity is the property we associate with data that appears the same regardless of the time scale at which it is viewed i.e. the data's distribution remains unchanged. Since a self-similar process has observable bursts on all time scales, it exhibits long-range dependence; values at any instant are typically correlated with values at all future instants.

The OC-3 data on day 1 consists of many VC/VP's and the cell counts for each of them over 24.5 hour period. The data used for this part of the study is the cell count over 5 ms intervals of a particular VC/VP (4/511) for the entire day 1 (Fig.2). There are more than 17.5 million cell counts in this data set. Another data set of 17.5 million independent, exponentially distributed cell counts was generated with a mean equal to that of the given data for comparison purposes.

The following plots were generated and observed:

- Peak Rate Vs log of averaging time interval for the data on day 1.
- The probability distribution function of the exponentially distributed data was plotted to verify the exponentiality of the distribution.
- Peak Rate Vs log of averaging time interval for the exponentially distributed data.
- Expanded view of the features in the Peak Rate Vs Averaging interval (hours) by plotting the Peak Rate Vs Averaging interval in minutes, seconds and milliseconds for a particular hour. The hour that contains the peak of the given 5 ms data is chosen to expand.
- The above method is repeated for the exponentially distributed data.

### ***Peak Rate Vs logarithm of Averaging Interval:***

The 5 ms cell counts are aggregated over different time intervals and the peak rate (in Mb/s) for each time interval is plotted versus the time interval (the latter being in log scale for visualization of the features in smaller aggregation intervals). From Figure 2, it can be seen that the peak rate is maximum for no aggregation (5 ms), remains high throughout the aggregation interval for about 25 seconds, then falls off when aggregated further. Note that the peak rate remains more or less constant for some aggregation intervals (0.1 sec-25 sec). The peak rate for 5 ms and 1-hour aggregation interval is approximately 11.4 Mb/s and 3.7 Mb/s respectively. Note also that the peak rate falls abruptly for aggregation intervals beyond 100 seconds.

It may seem to the reader that the peak rate should be monotonically decreasing as aggregation interval increases, but Fig.2 shows several jumps. The occurrence of these jumps in figure 2 can be explained by this example:

Let a set of points (cell-counts) be considered which is a subset of the actual data with a measurement period of 5 ms between each cell count. A 50 ms duration implies 10 points in the set with a basic measurement period of 5 ms.

Set: {0, 0, 2, 20, 1, 16, 0, 6, 0, 0}

It is important to note that cells are aggregated over non-overlapping blocks of time for calculating peak rate. When the 5 ms interval is considered, the peak rate would be **1.696** Mb/s as the 4<sup>th</sup> element accounts for the highest cell count in that interval.

$$(20*53*8)/5\text{ms} = \mathbf{1.696} \text{ Mb/s}$$

Summing the cells for an aggregation of 10 ms, the peak occurs in the second 10 ms slot (3<sup>rd</sup> & 4<sup>th</sup> element in the set), which would be

$$(20+2)*53*8/10 \text{ ms} = \mathbf{0.933} \text{ Mb/s}$$

This exhibits the expected decrease in the peak rate. However, summing the cells for an aggregation of 15 ms, the peak rate can be obtained by adding the second 15 ms slot (4<sup>th</sup>, 5<sup>th</sup> & 6<sup>th</sup> element in the set) which would be

$$(20+1+16)*53*8/15 \text{ ms} = \mathbf{1.14} \text{ Mb/s}$$

Therefore, depending on the traffic, the peak rate might increase as aggregation increases, and this behavior is exhibited in Fig.2

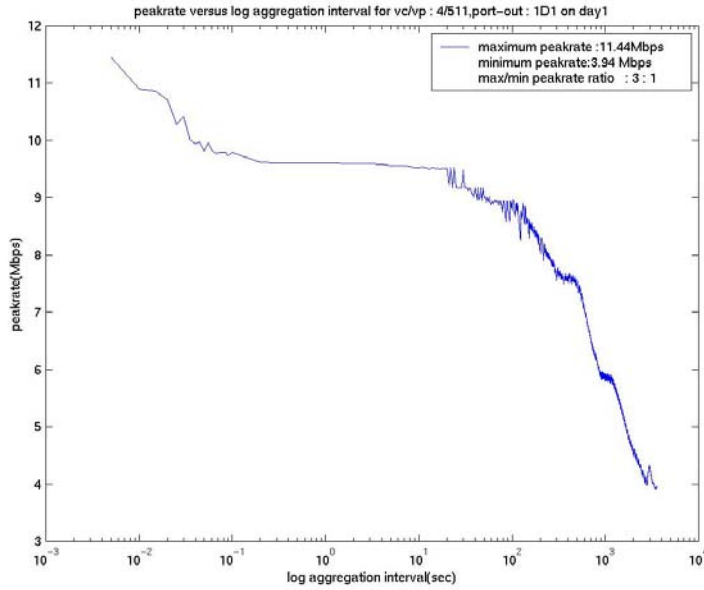

Fig. 2

***Comparison with exponentially distributed data:***

Exponentially distributed data was generated by transforming uniformly distributed data and the mean was equated to that of the collected data. Fig 3 shows that the probability density of the generated data is exponential. Fig.4 shows that the peak rate in the generated falls off with increasing time aggregation in an exponential-like fashion and remains essentially constant after 100 seconds, whereas for the collected data (Fig.2) the peak rate remains constant for aggregation intervals ranging from 0.25 seconds to 25 seconds and falls off abruptly after that.

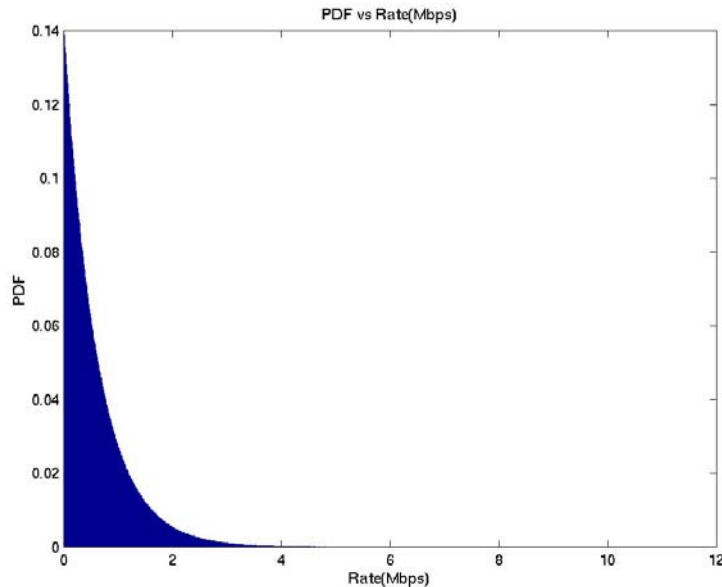

Fig. 3

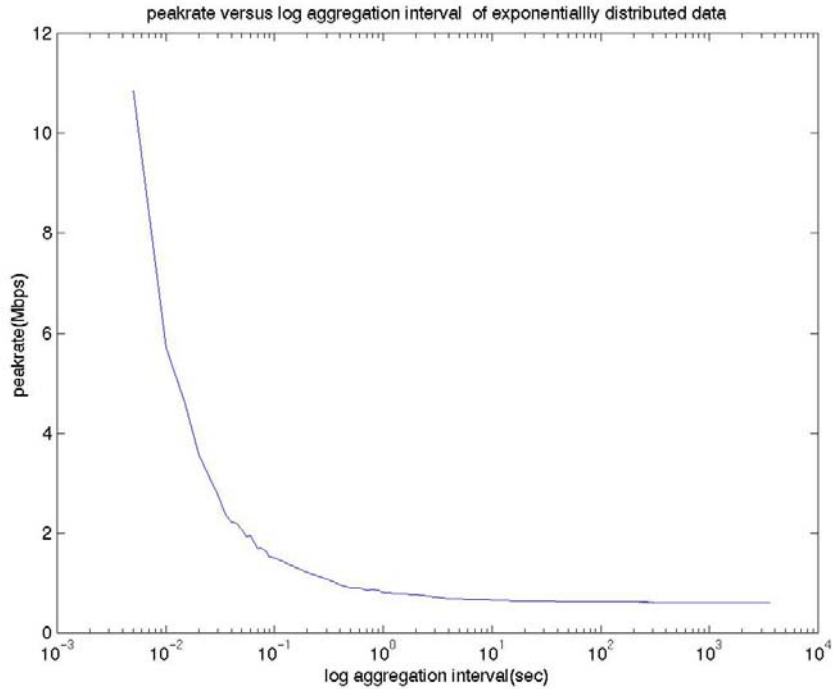

Fig. 4

***Peak rate for the expansion of timescales:***

The graphs with averaging time interval of one hour, one minute, one second and 5 ms (collected data) are plotted in Figures 5 – 8. It can be noted from figure 5, that the 5 ms peak occurs between 6 p.m. and 7 p.m. but this is not the interval in which the peak of the hourly aggregated data occurs (4p.m. – 5 p.m.). By expanding the 6 p.m. to 7 p.m. interval window into minute window (Figure 6) and then to seconds window (Figure 7), and finally to 5 ms window (Figure 8) the peak in each window occurs at a different point of time. This expansion from a larger time scale to a finer time scale helps in understanding the self-similar behavior of data. The self-similarity can be identified by the non-uniformity in traffic with increase in aggregation interval. Also, Figures 5 through 8 appear similar (considerable burstiness) regardless of the scale at which the data is viewed. The data clearly appears to be self-similar.

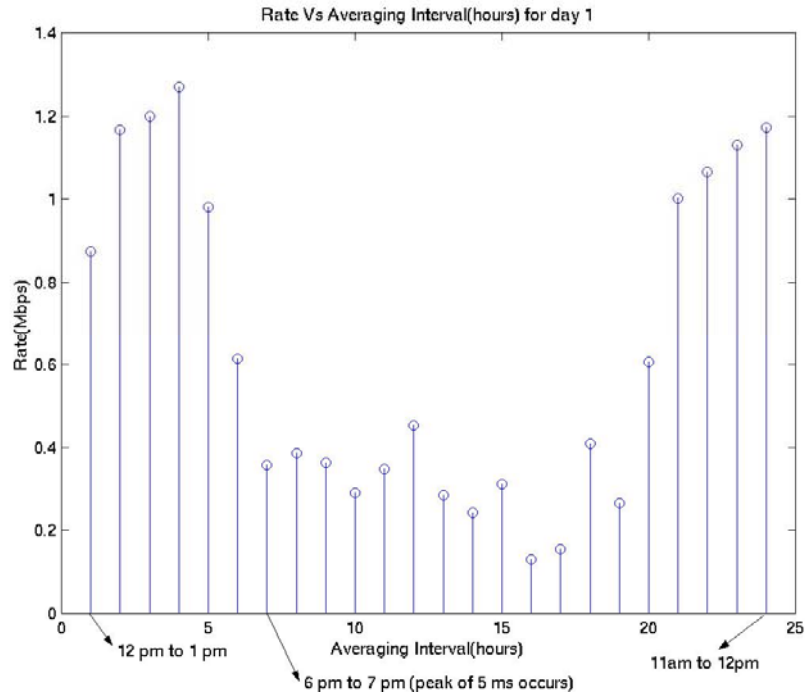

Fig. 5

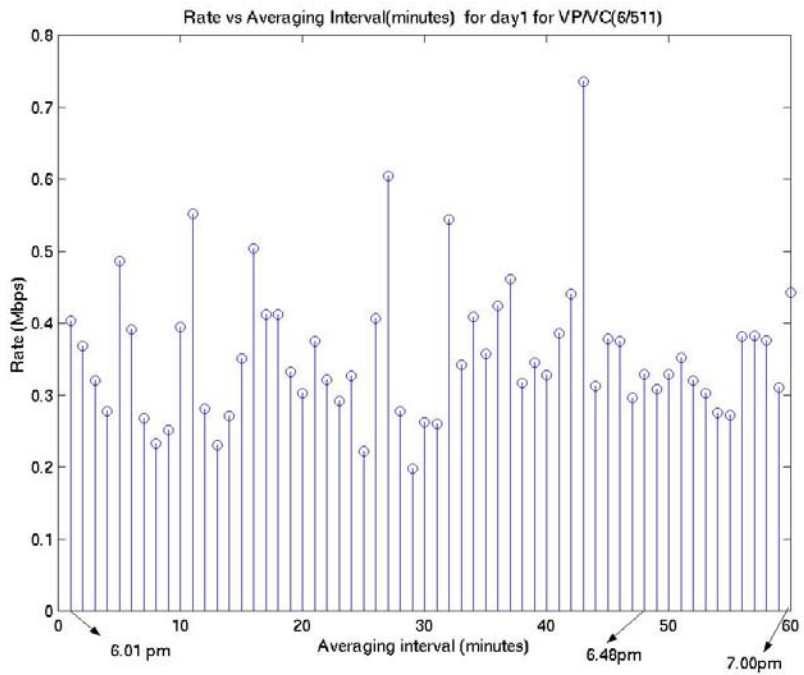

Fig. 6

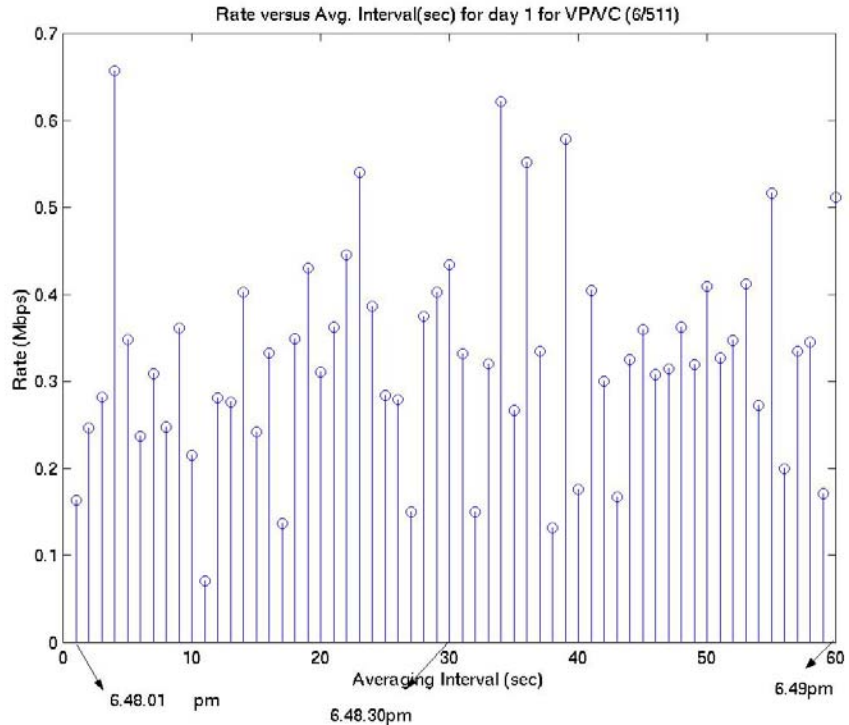

Fig. 7

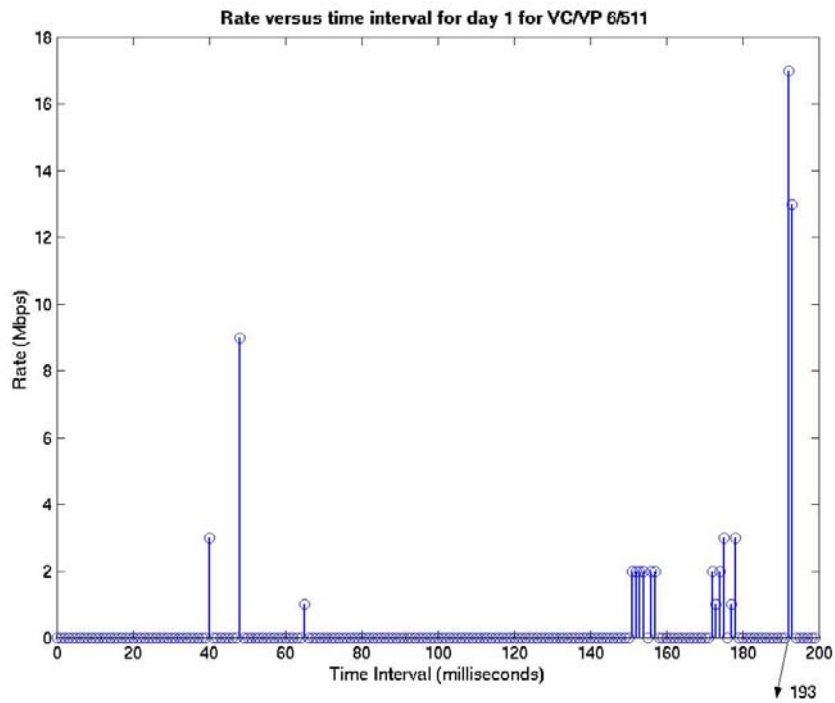

Fig. 8

Figures 9 through 12 repeat the same expansion sequence for the exponentially distributed data. From Fig .9, it can be observed that the bursts smooth out resulting in a constant rate (bits /second) as the aggregation interval increases. This indicates that the independent data is not self-similar. A more complex model is required to do analysis on the collected cell-count data.

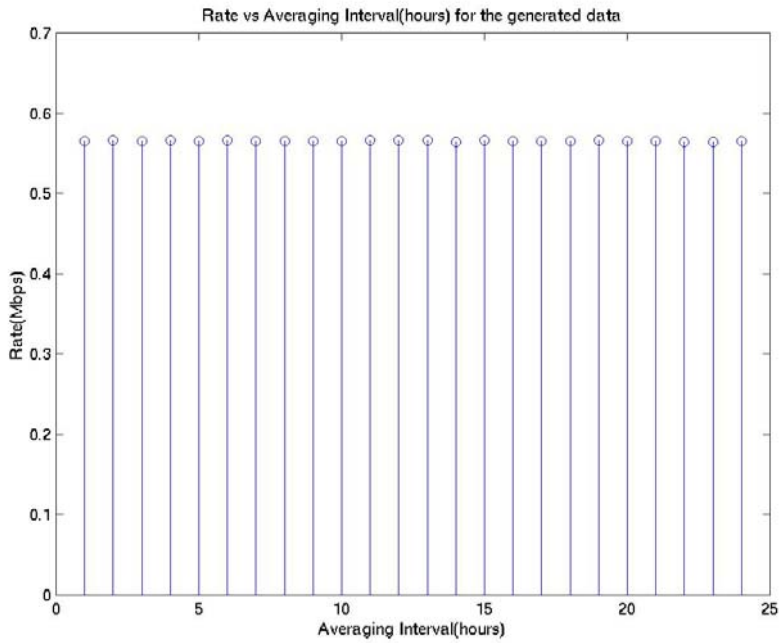

Fig. 9

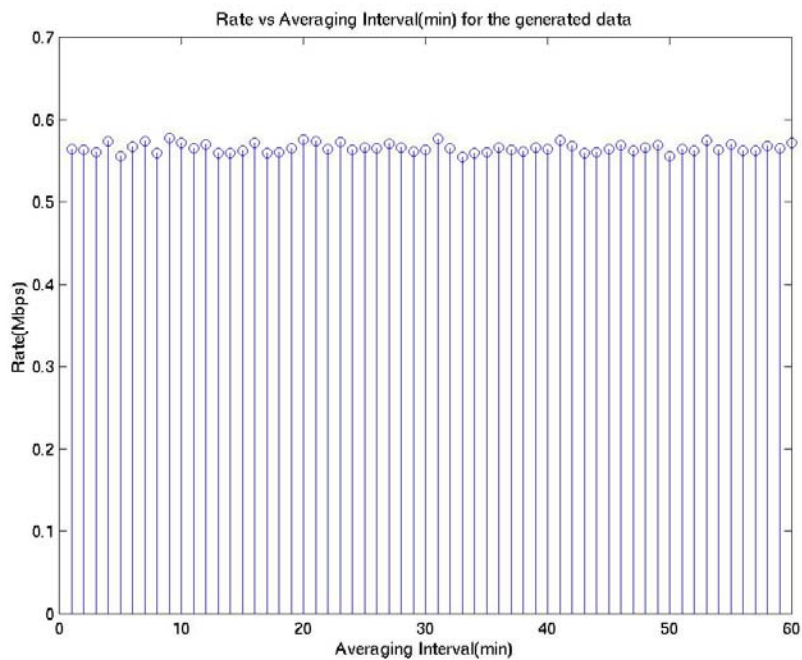

Fig. 10

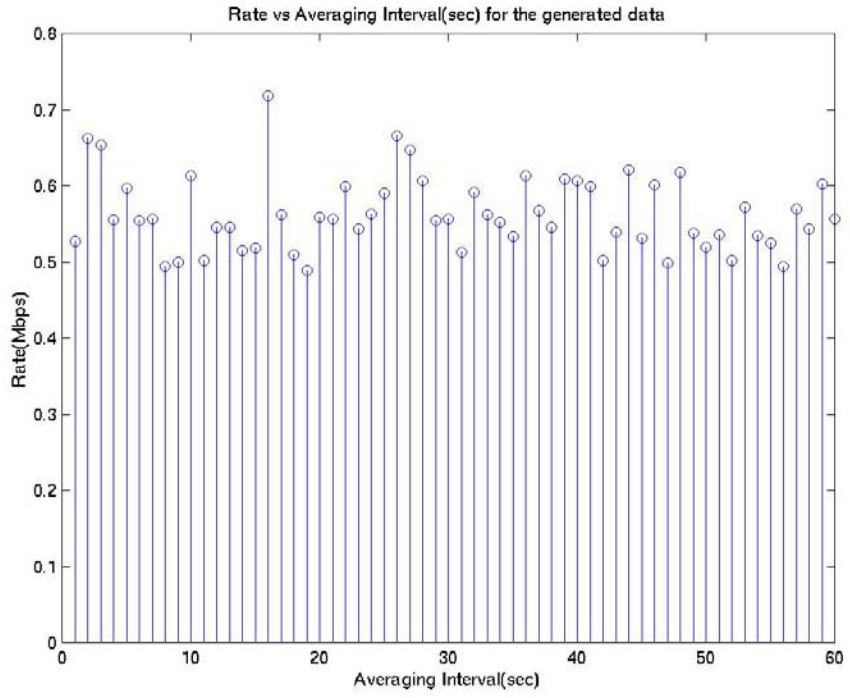

Fig. 11

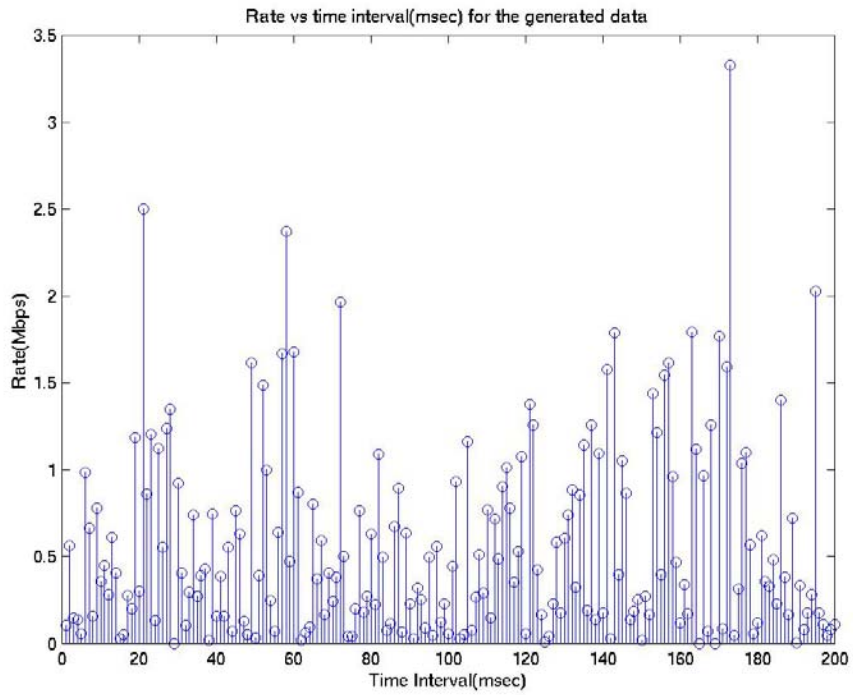

Fig. 12



## Peak rate of Links:

Peak rate is the upper bound on the traffic flow on an ATM connection. We now turn our attention to traffic on an entire OC link. Each day's cell-count data on different links at different switches is analyzed to obtain the peak rate over different aggregation time scales. . Link data can be obtained by summing VCC cell counts for all VC/VP pairs on a given OC-x link (where x can be either 3 or 12).

Figures 13 and 14 show the expected decay in the peak rate as the aggregation time interval increases in both OC-3 and OC-12 links. The sharpest drop occurs in the region of 10ms-100ms aggregation. Note the difference between peak rate at finer time scales versus peak rate at the 1hour time scale. Clearly, 1-hour averaged data does not give an accurate indication of possible link congestion, which can occur in much smaller time scales. Peak rate versus aggregation curves for all the links are given in Figures 21-28 in the Appendix.

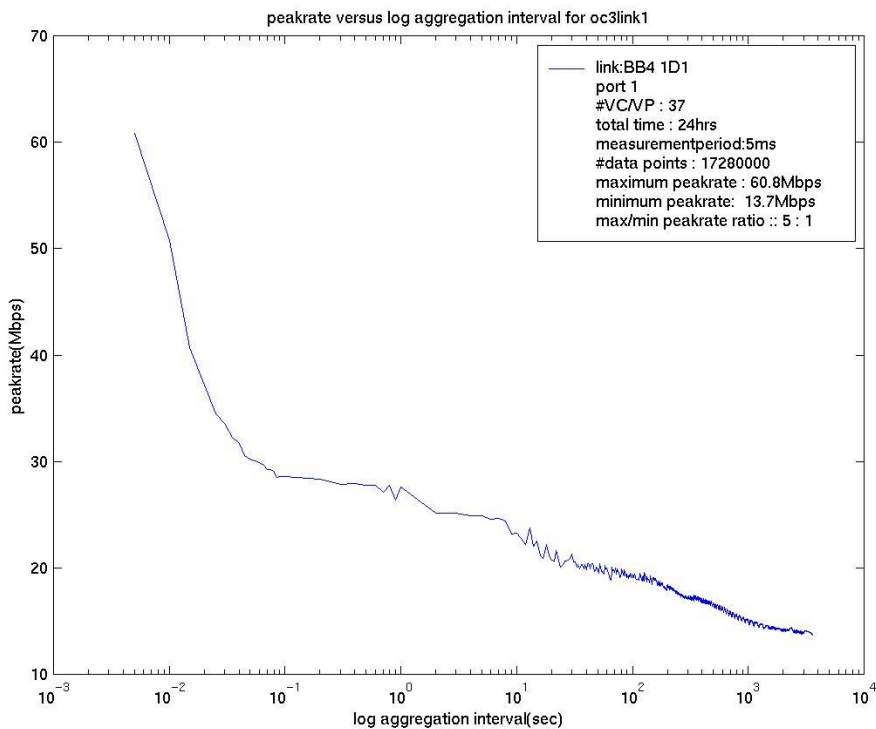

Fig.13

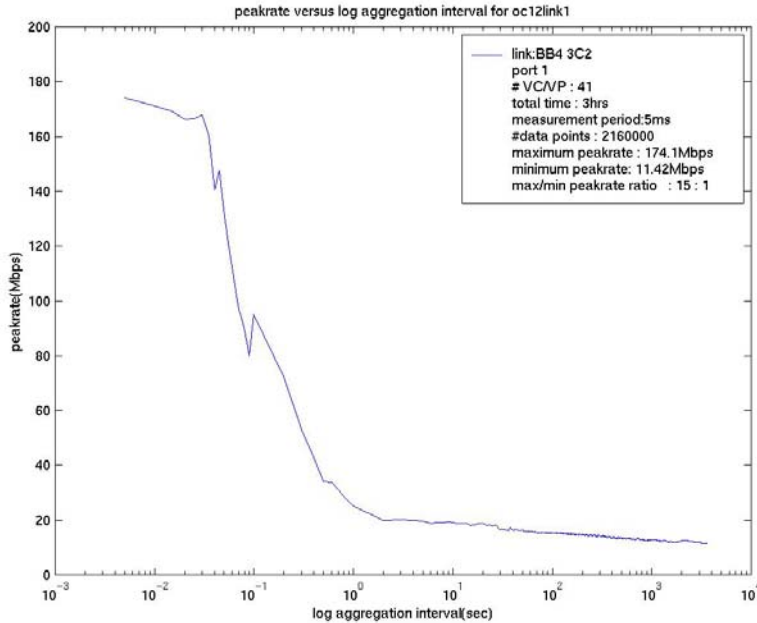

Fig 14

**OC-3 link:**

The OC-3 refers to the SONET transmission rate of 155 Mb/s, which is widely deployed in ATM networks. Our analysis deals with all the VCCs in three OC-3 links. The peak rate study of the link does not specify the details of the traffic behavior in its VCCs but the traffic as a whole in the link that is derived from its VCCs.

The day 1 data at port-out with port number 1D1 was collected on 37 VCCs with the measurement period of 5 ms and the total number of data points used for the study are 17280000 (24 \* 3600/ 5ms). Cell-counts aggregated over non-overlapping blocks of time are used for calculating peak rates at different aggregation time scales(Fig.13).

It can be observed that the peak rate falls as the aggregation interval increases and the minimum peak rate is obtained for aggregation of data over an hour. The maximum peak rate of 60.8 Mb/s (aggregated at a lower time scale of 5 ms) and a minimum of 13.7 Mb/s for aggregation over 3600 seconds (1 hour) indicating approximately 75% drop in the peak rate. The ratio of maximum to minimum peak rate is 5: 1, which depicts the rapid decay of peak rate in this particular link. The maximum expected peak rate on any link would be equal to capacity of that link. It is interesting to note that at finer time scales (microseconds), the link might achieve the OC-3 link capacity. The ratio of 5 ms peak rate to 100-second peak rate is equal to the ratio of 100-second (aggregation interval) peak rate to the 1-hour peak rate.

By observing the figures 21 and 22 in Appendix, it can be noticed that the ratio of maximum to minimum peak rate is 9: 1 and 6:1 with maximum peak rates being 41.29 Mb/s and 32.7 Mb/s respectively. One inference that can be made after the above observations is that none of the links reach even half the capacity of the OC-3 link with minimum

aggregation interval being 5 ms. It does not prove that max link capacity (155 Mb/s) is not reached since link capacity could be reached at finer time-scales (micro-second level). Note that Figures 13,21 and 22 (OC-3 links) have remarkably similar shapes.

***OC-12 link:***

The OC-12 refers to the SONET transmission rate of 622.08 Mb/s. Data on three OC-12 links were collected with measurement period of 5 ms on two of the links and 10 ms on the other. The duration of measurement varied on all three days on different links (refer to Table 2).

Figures 23 and 24 are the result of data obtained on port-in & port-out (#3C2) for 3 hours on day 1 and the peak rate of the link over wide range of time scales is calculated with a total number of 2.1 million data points. The ratio of maximum to minimum peak rate on both the links is almost the same being approximately equal to 14: 1.

The peak rates for all OC-12 link can be noted from Figures 23-28. The peak rates of all OC-12 links are approximately 175 Mb/s and the ratio of maximum to minimum peak rate is also approximately the same. Similar to the OC-3 links, these links do not reach the OC-12 link capacity of 622 Mb/s for 5 ms aggregation but may reach the maximum link capacity at a finer time scale.

***Ratio of maximum to minimum peak rates of the links.***

Analysis of the ratio of maximum to minimum peak rate is done in order to show that there is a linear relationship between the ratio and peak rate at one-hour aggregation. Given the one-hour peak rate, the maximum peak rate of OC-links can be calculated by the equations described below

Equation for OC-3 link ( refer to fig.15)

$$\mathbf{R \log = - 0.5032*oc3log + 1.2071 .....(1)}$$

Where ‘Rlog’ is the logarithm of ratio of maximum to minimum peak rate and ‘oc3log’ is the logarithm of hourly peak rate (Mb/s) of OC-3 link.

Equation for OC-12 link ( refer to Fig.15)

$$\mathbf{R \log = - 0.9136*oc12log + 2.1516 .....(2)}$$

'Rlog' is the logarithm of ratio of maximum to minimum peak rate and 'oc12log' is the logarithm of hourly peak rate (Mb/s).

Given the peak rate at one-hour aggregation of a link, the ratio can be calculated and multiplied by the one-hour peak rate to obtain approximate 5 ms peak rate.

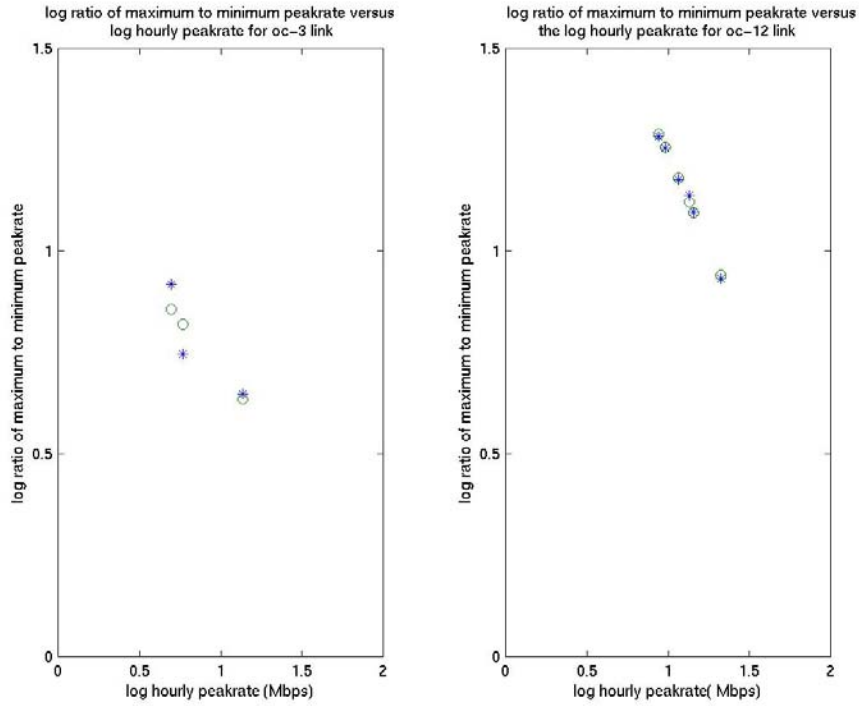

Fig.15

**Peak rate of a VC/VP:**

**Peak rate of a single VC/VP:**

Peak rate of a VCC indicates how active it is on its OC-link and therefore we analyzed the cell-count data of a particular VCC (4/511) to observe its behavior on all the links. Specific patterns in the traffic that occurred on each type of OC link are discussed in this section.

Fig.16 shows the similarity in the traffic pattern for one VCC on an OC-3 link (except for day 3 collected data). The three subplots in Fig.16 correspond to data collected on days 1 through 3 at port 1D1 on an OC-3 link. Larger plots for these 3 days are given in Figures 29-31. The peak rates on days 1 and 2 are 11.4 Mb/s and 10Mb/s respectively, which indicate a similar traffic flow on these 2 days. Another similarity that can be seen is the constant rate around one-second-aggregation interval. As mentioned in earlier sections, aggregation over larger time intervals reduces the peak rate.

A strange behavior of the link on day 3 (Fig. 16) is observed in which there is no existence of the burst and the peak rate falls smoothly unlike the other link peak rate curves. The reason for this strange pattern might be atypical behavior of traffic on day 3 that is yet to be explored.

Figures 36 and 37 are the subplots relating to the traffic of a given VCC on days 1 and 2 on an OC-12 link Larger plots for these 3 days are given in Figures 32-35. The subplots in each plot (Figs. 36 and 37) are the result of data collected on same day and on same port but in different directions. Traffic on the OC-12 link had almost the same traffic pattern irrespective of the day of measurement. To achieve high utilization with bursty traffic, it is necessary that the sum of the peak rate for all the VCs over a link be higher than the link peak rate. It can be observed from the table below that the sum of maximum peak rates of VCCs in a particular OC link is much greater than maximum peak rate of that OC link. The ratio of sum of maximum peak rates of VCs in OC link to the maximum peak rate in OC link is around 5.5 for OC3 links (excluding OC link3 i.e. day 3 data ) and between 2 and 3 for OC12 links. The ratio is 21 for day 3, which is another evidence for the strange behavior of traffic on day 3.

OC link #	Measurement Period(ms)	Sum of maximum Peak rates of VCs In OC link (V) (Mb/s)	Maximum peak rate of OC link(O) (Mb/s)	Ratio (V/O)
OC3link1	5	324.9	60.8	5.34
OC3link 2	5	227.2	41.2	5.50
OC3link 3	5	687.2	32.7	21.0
OC12link 1	5	361.1	174.1	2.07
OC12link 2	5	421.2	184.6	2.28
OC12link 3	5	376.2	171.7	2.19
OC12link 4	5	499.2	179.5	2.78
OC12link 5	10	388.5	168.6	2.30
OC12link 6	10	533.6	181.1	2.94

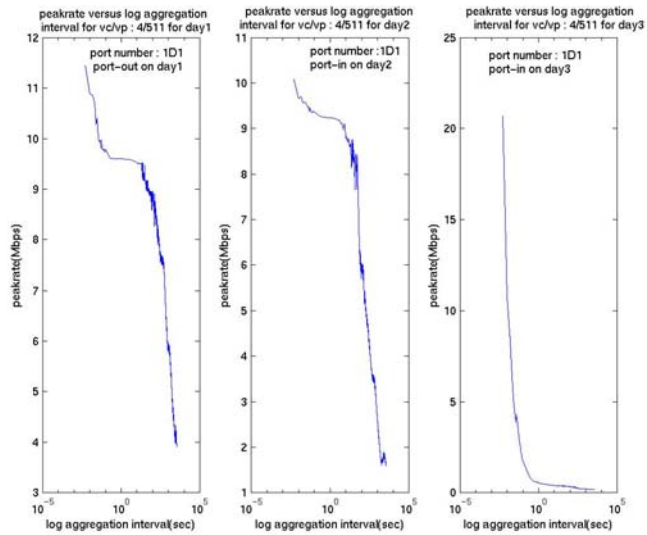

Fig.16

***Ratio of maximum to minimum peak rate of VCC's:***

We now investigate the ratio of the maximum to minimum peak rate of the VCCs, in particular as a function of hourly (minimum) peak rate. The specific pattern in the Figures 17 (OC-3) and 18 (OC-12) are typical of all the VCCs in all the links except in the case of the traffic measured on day 3 on an OC-3 link. This similarity in pattern occurs in all the VCCs in all the links, except for day 3. The ratio plot for day 3 on OC-3 link shows a single point (Figure 38 in Appendix) representing a cluster of peak rate points all with an hourly peak rate of about 200 Kb/s and all with a ratio (maximum/minimum of peak rate) of about 100. This also is evidence of the strange behavior of the link on port 1D1 on day 3.

The similar pattern in the other figures (39-44) in the Appendix confirms that certain VC's carried heavy traffic and it resulted in the high peak rate in its link. The peak rate of VCC's on all links can be estimated from Figures 39-44. All the links have a regular pattern indicating similar traffic flow in them.

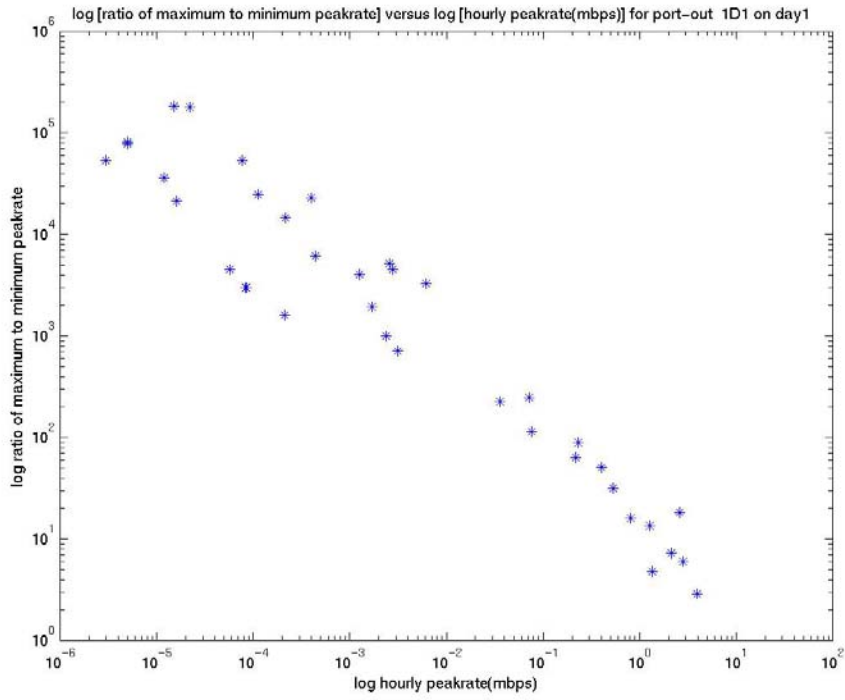

Fig.17

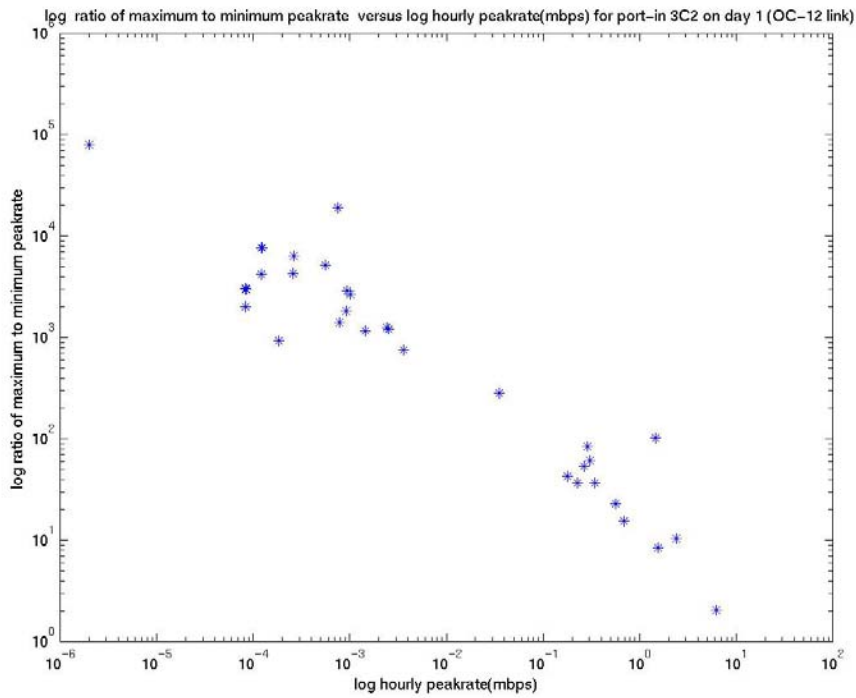

Fig.18

Finally, an equation can be obtained for the peak rate of a VCC on an OC-link. Figure 19 plots the logarithm of ratio of maximum to minimum peak rate of all VCC's combined

sketched on a single plot. The resulting linear fit (equation 3) can be used to characterize the behavior of VCC's in the OC-links. The density of ratio points towards the upper end of the straight line indicates higher peak rates in the VCCs.

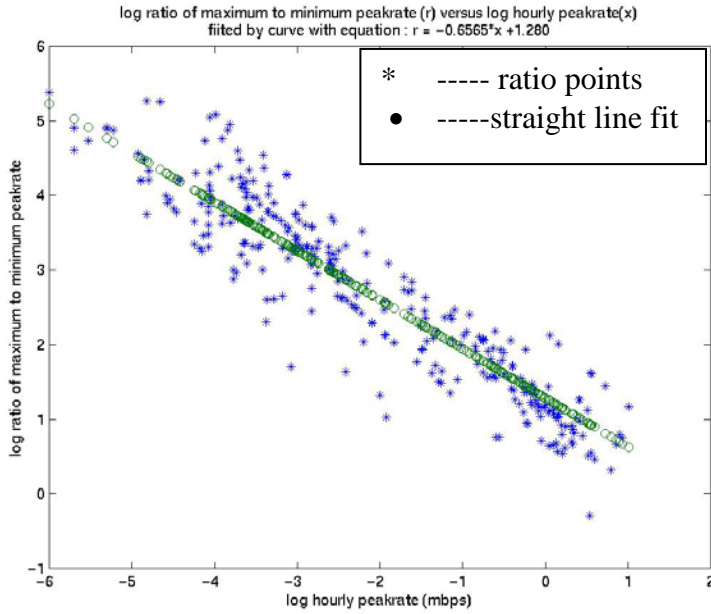

Fig 19

The equation of the straight-line fitted to the cluster of ratio points is

$$rlog = - 0.6565 * hlog + 1.2870 \dots\dots\dots(3)$$

Where ‘ rlog’ is the logarithm of ratio of maximum to minimum peak rate and ‘hlog’ is the logarithm of hourly peak rate (Mb/s) of all the VCCs.

***Comparison of peak rates in OC-links and its VCCs:***

Figure 20 is the Peak rate versus Logarithm of aggregation interval of OC-3 link and one of its corresponding VC/VP (4/511). There is a rapid fall in the peak rate in VCC traffic at around 100 second aggregation interval and at 100 millisecond interval in OC link traffic (Fig.20) which indicates a difference between peak rate curves in OC links and its VCCs. The rate at which peak rate drops from 5 ms to 100 seconds is much less than the peak rate fall from 100 seconds to one-hour aggregation adding another point of difference between OC and VCC curves. There is a more gradual decrease in peak rate of a link as opposed to the rapid decrease in peak rate in its VCCs. Similar traffic pattern indicates consistency in the traffic on all the VCCs in OC-12 (Figures 23-32).



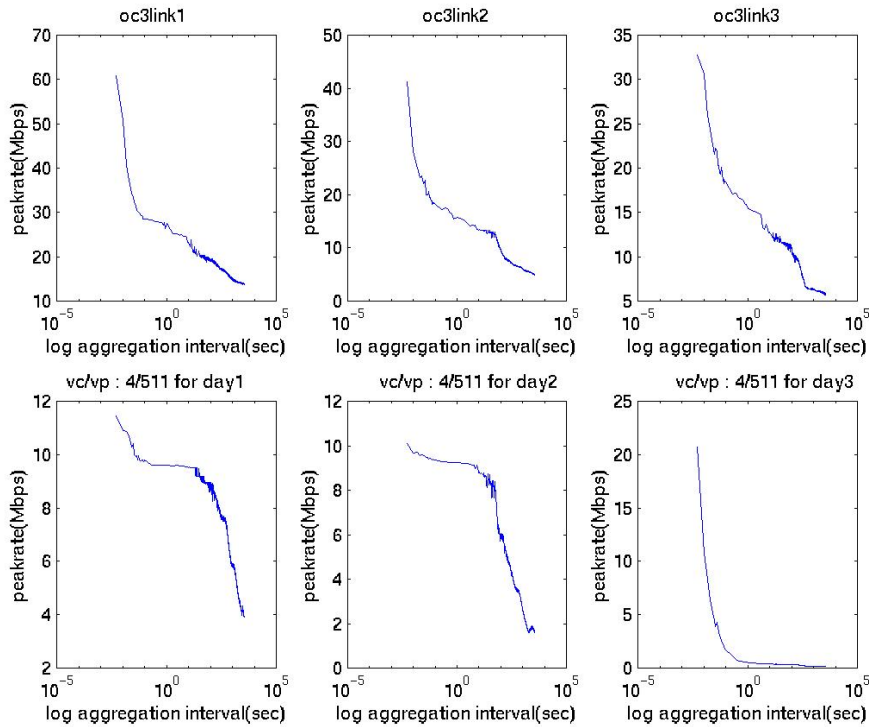

Fig.20

### Future Work:

- The traffic on the link on day 3 at port 1D1 is similar in its behavior to the traffic on other OC –3 links but the traffic on its VCCs exhibit strange behavior and this data should be analyzed to find the traffic characteristics and cause of the behavior. The different behavior of data can be noted from Figure 20 above as well as the Figure 38 in Appendix.
- The peak rate falls off rapidly at 100-second aggregation interval on the link whereas it decreases at around 100 ms aggregation interval in the link. This pattern difference in the links and its VCs should be explored.

## **Conclusions:**

- ✓ The ATM cell count data is self-similar and there is a need to build a complex model for further analysis of the data since networks in the past have been described by traditional Markovian models that are mostly used for short-range dependent data.
- ✓ Peak rate decreases as aggregation interval increases. Though the traffic can be said to be almost similar in the property stated in the previous line, it is different in respect of pattern of the decrease. In particular, peak rate falls most rapidly near 10 ms aggregation for the OC-3 links studied, near 100 ms aggregation for the OC-12 links studied, and over a wide range of aggregation intervals (10 ms to 100 ms ) for individual VCCs.
- ✓ Occurrence of peak in a particular interval is governed by the aggregation time interval. For different aggregation intervals, the peak occurs at different points of time.
- ✓ Equations 1 – 3 show that there is a specific pattern for traffic on OC-3 and OC-12 link and also for VCCs on the links.
- ✓ There is no much difference in the traffic in a particular VCC on different links captured on different days, which was noted by the regular pattern in the traffic.

## APPENDIX

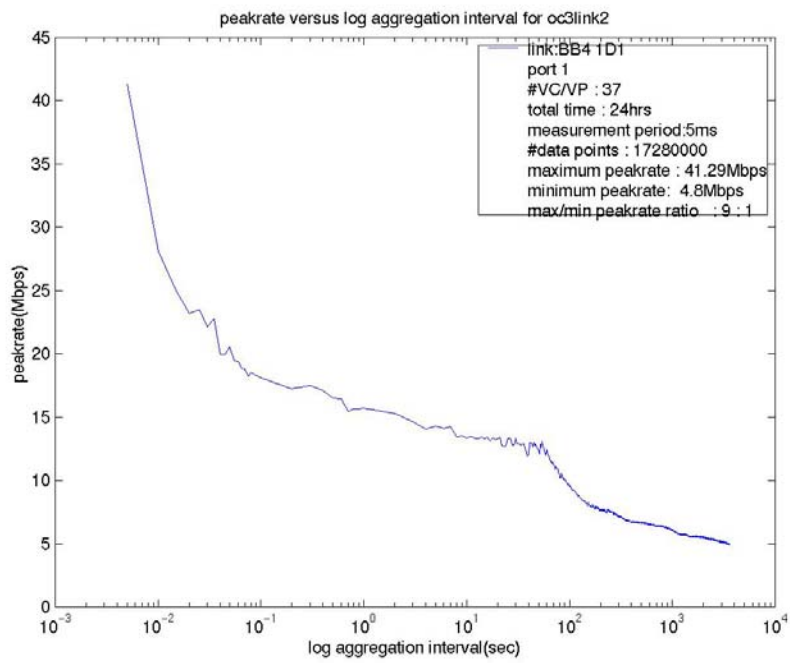

Fig.21

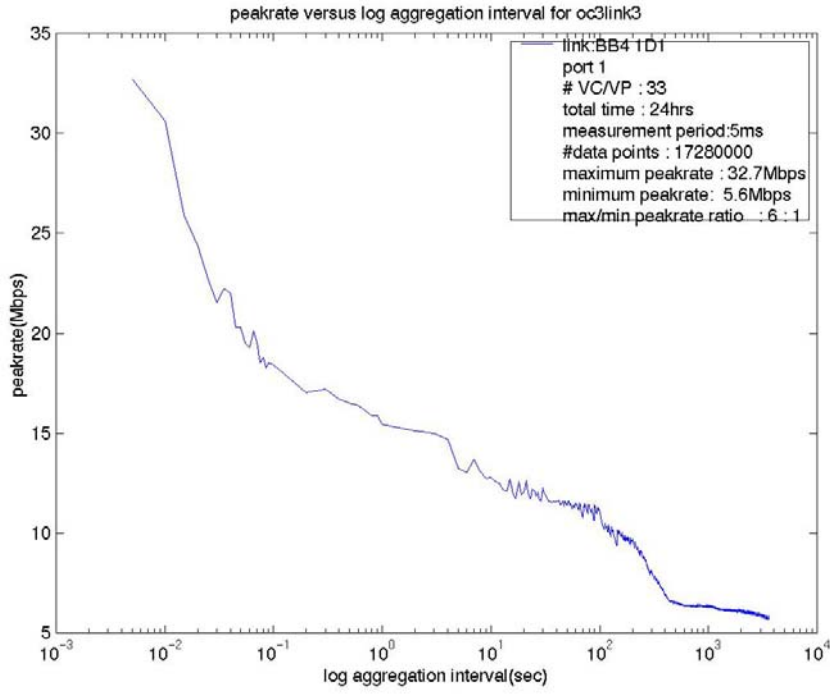

Fig.22

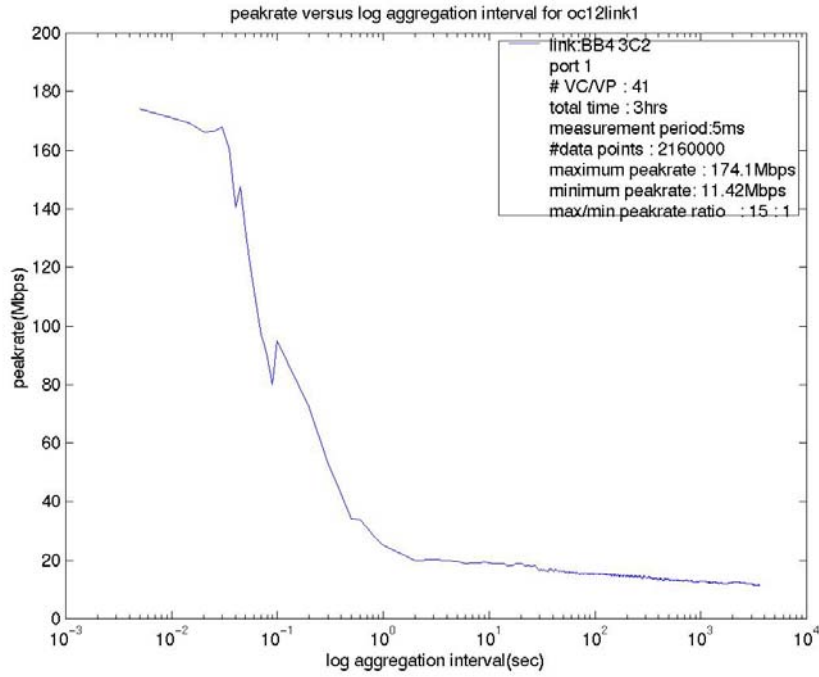

Fig.23

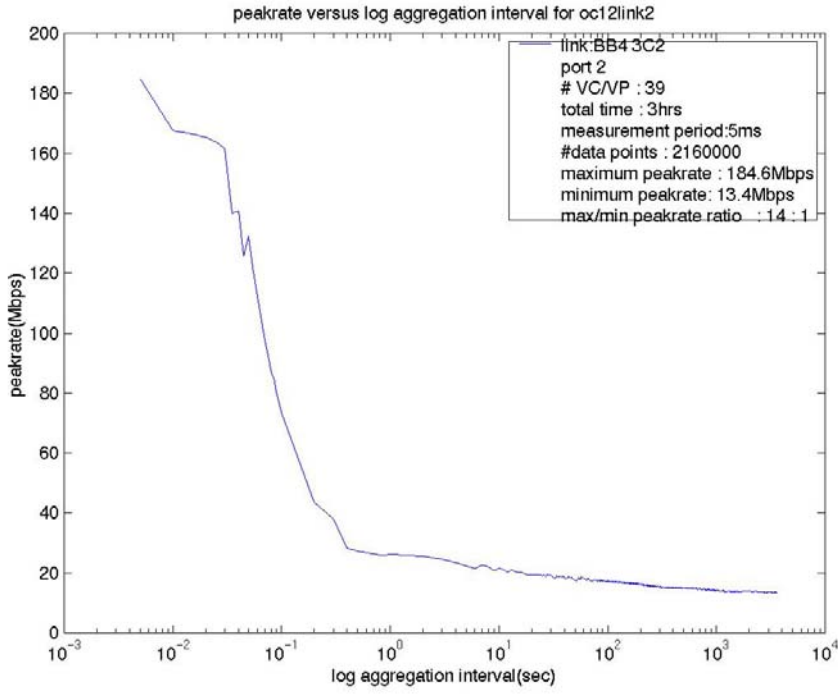

Fig.24

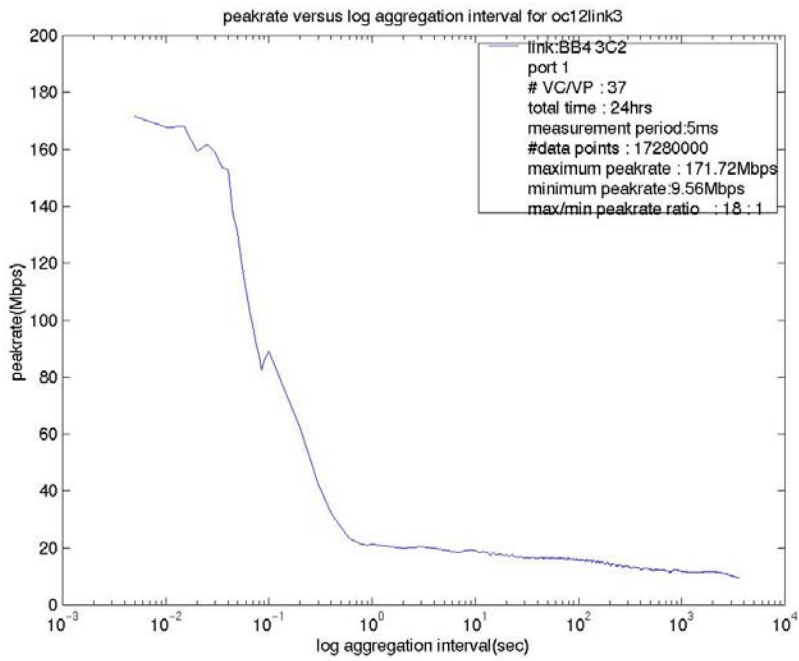

Fig 25

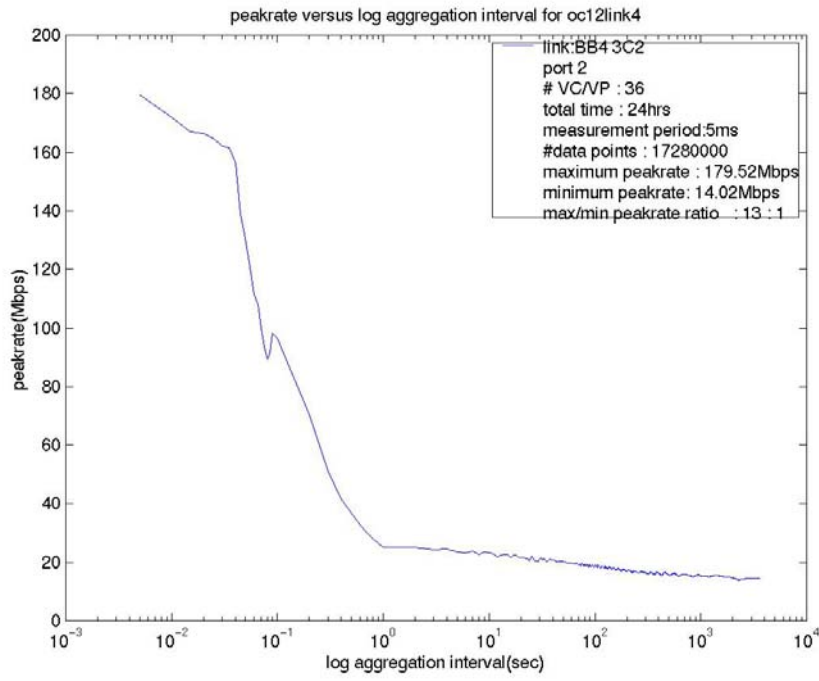

Fig.26

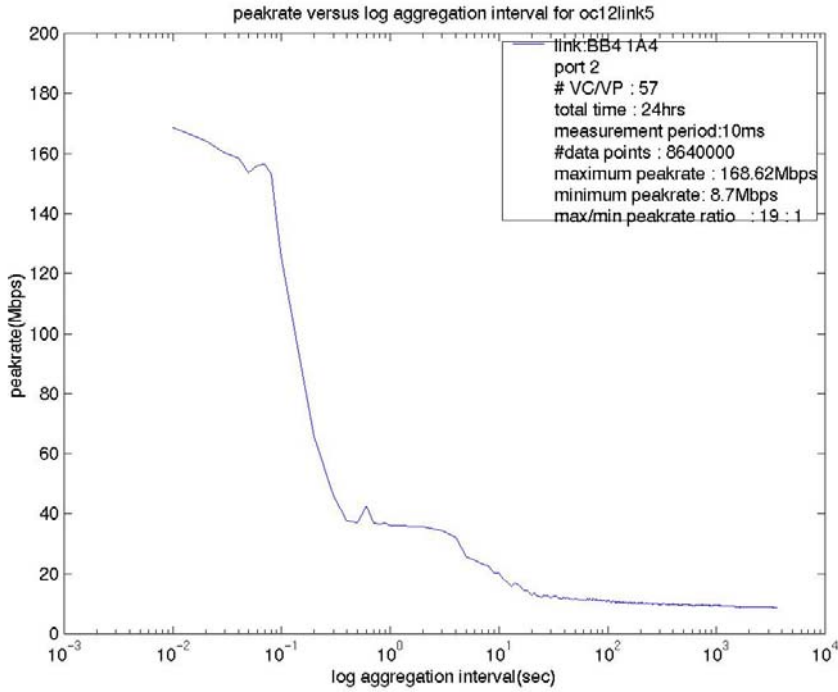

Fig.27

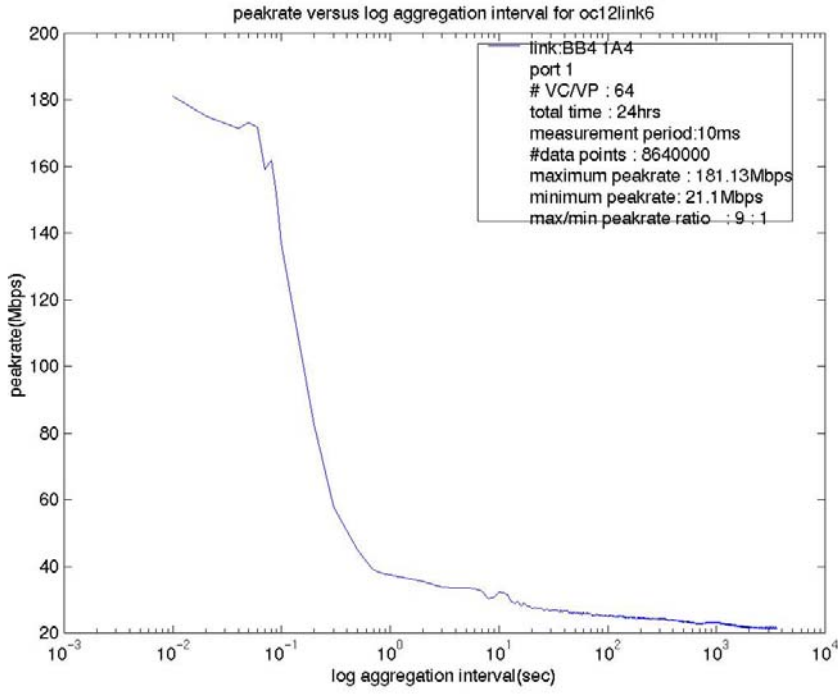

Fig.28

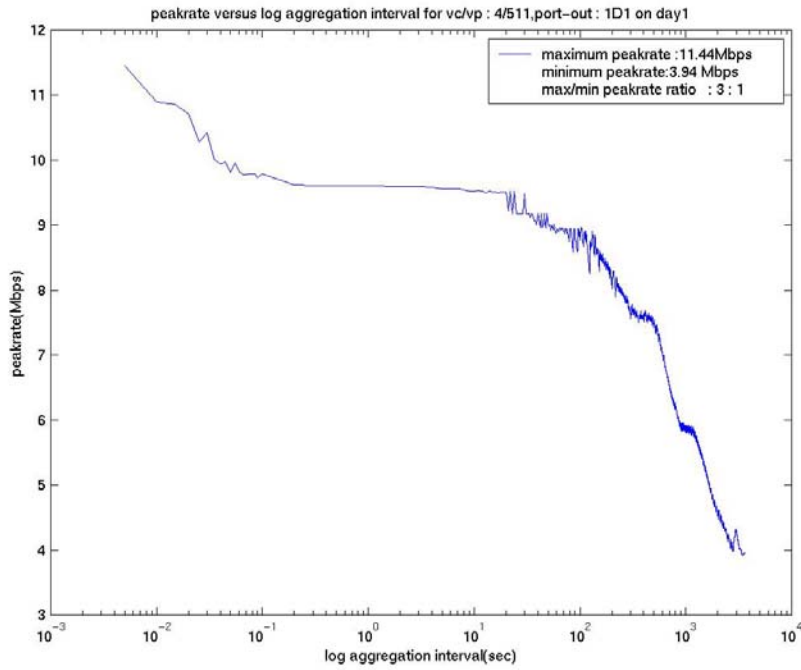

Fig.29

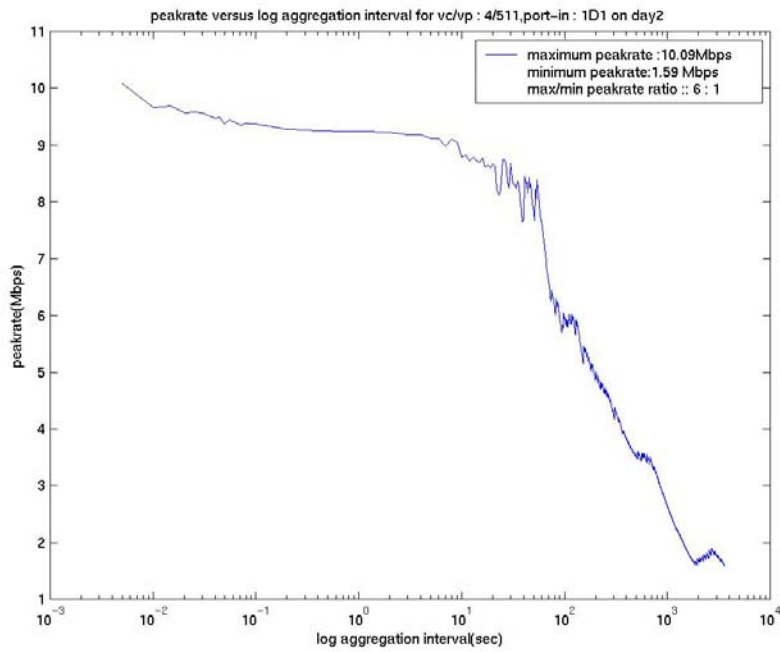

Fig.30



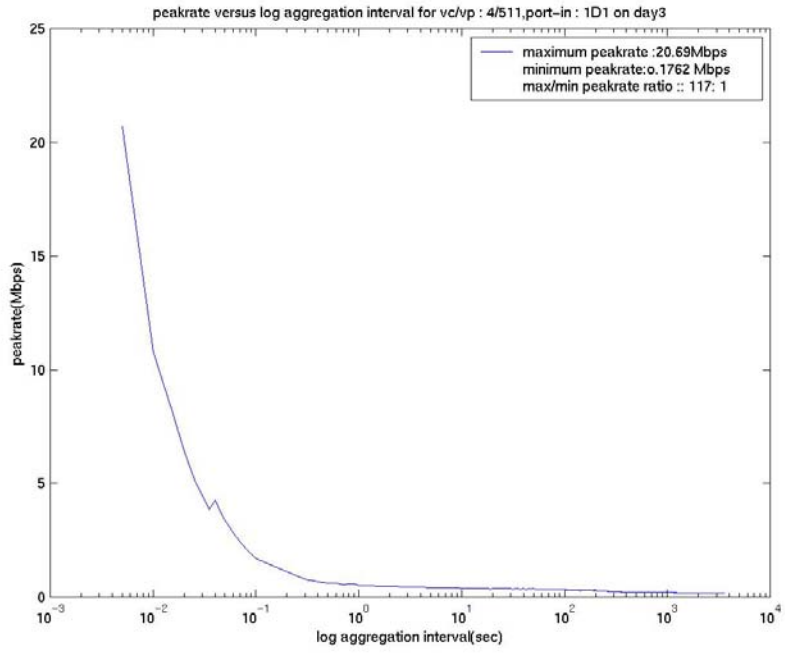

Fig.31

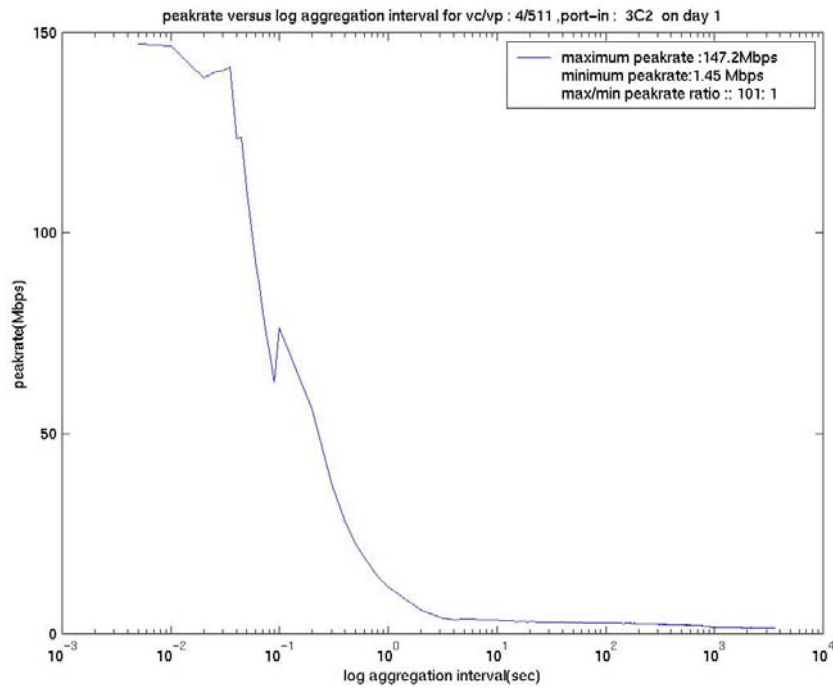

Fig.32

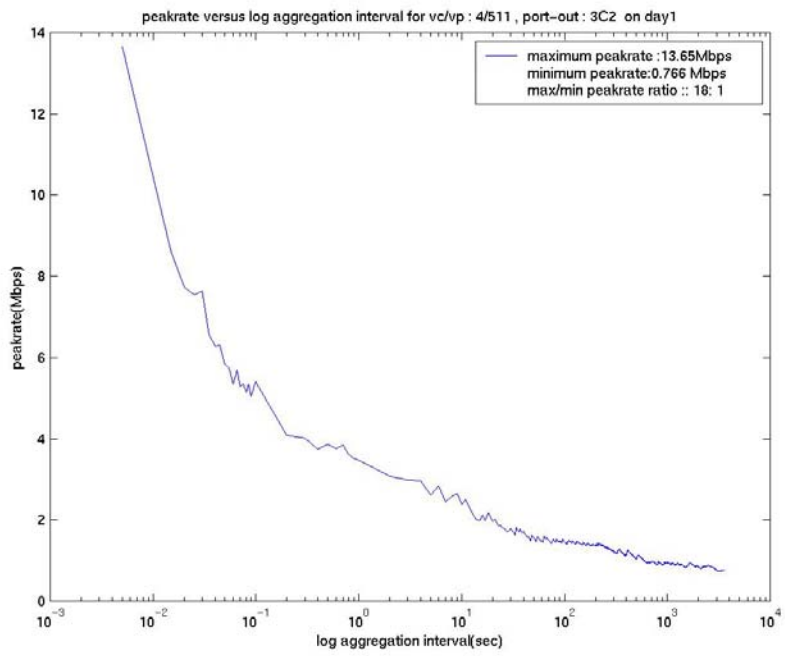

Fig.33

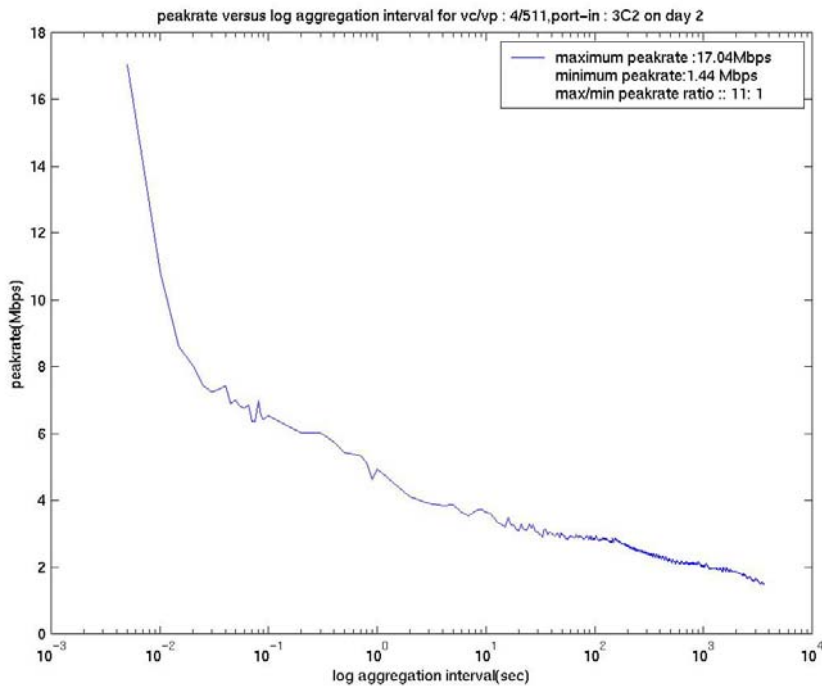

Fig.34

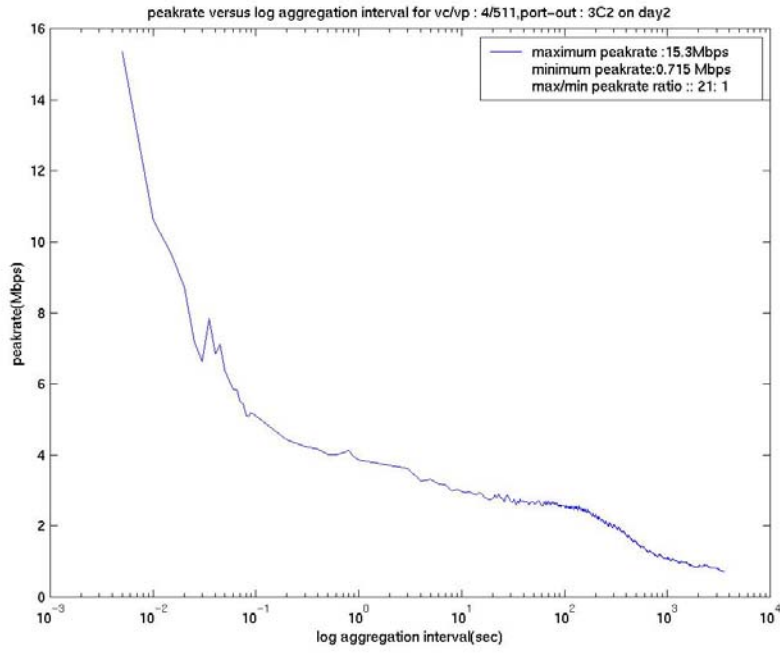

Fig.35

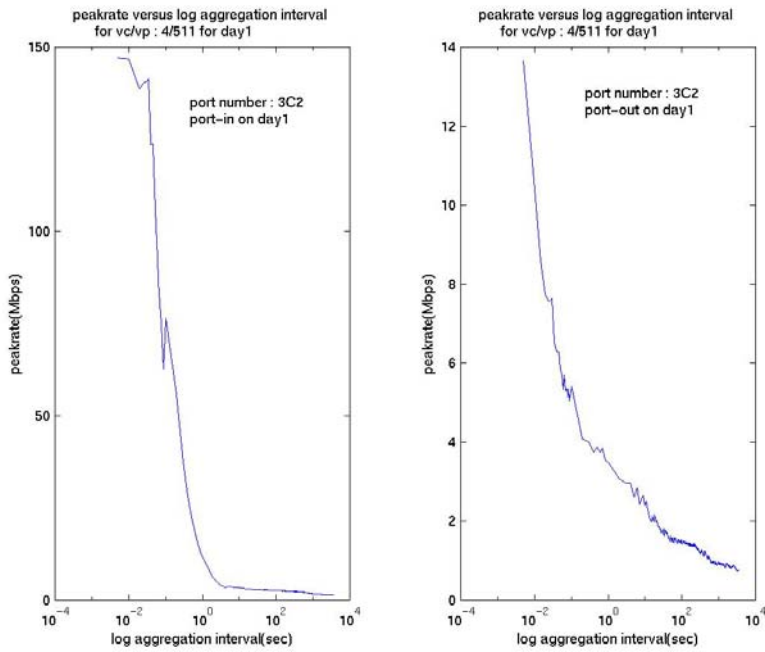

Fig.36

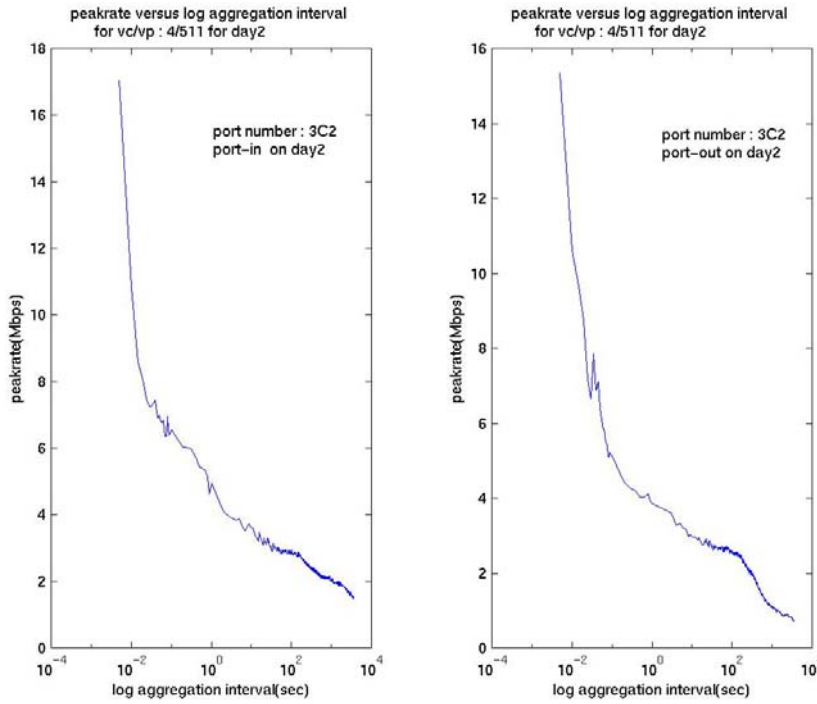

Fig.37

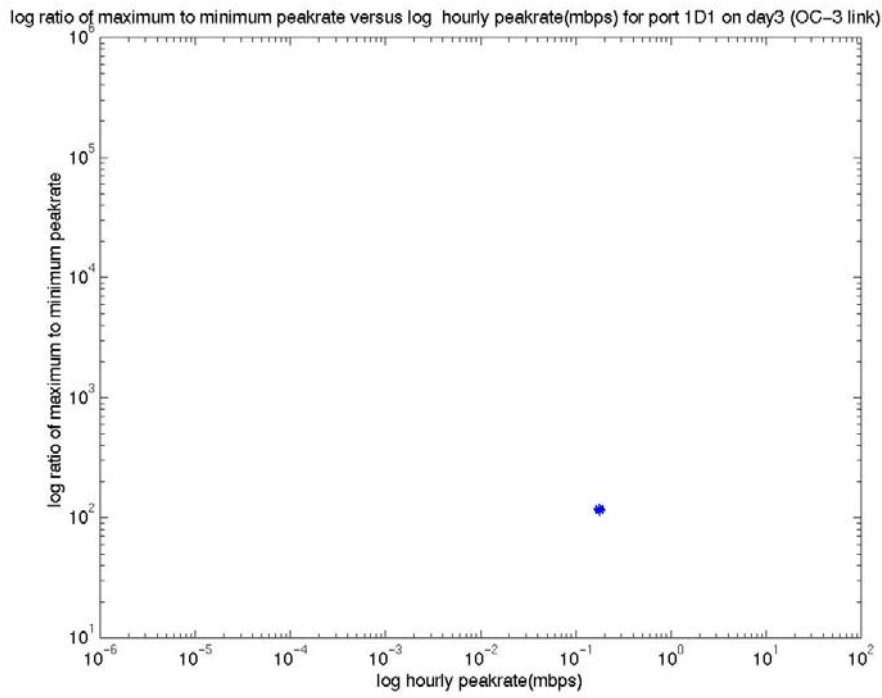

Fig.38

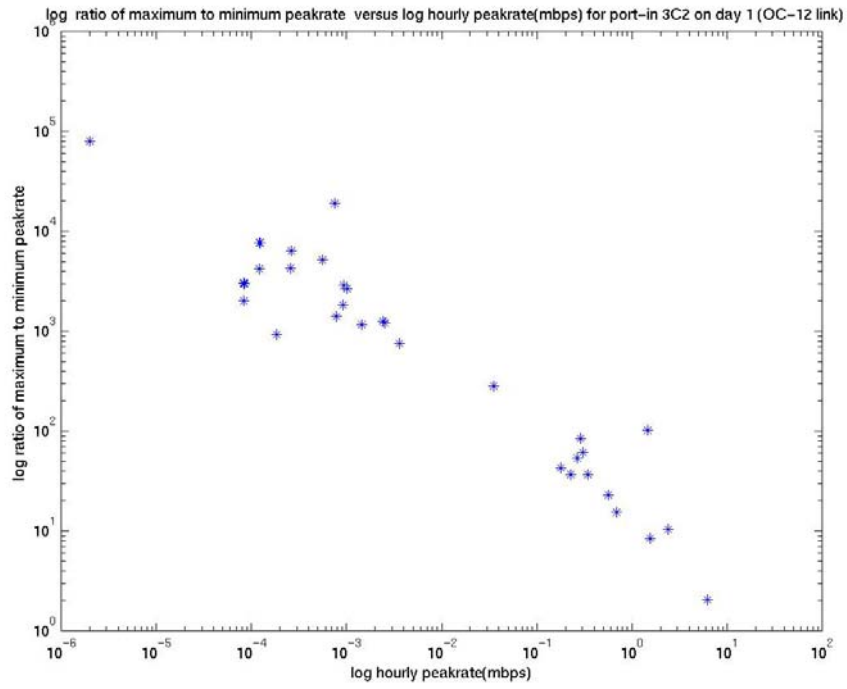

Fig.39

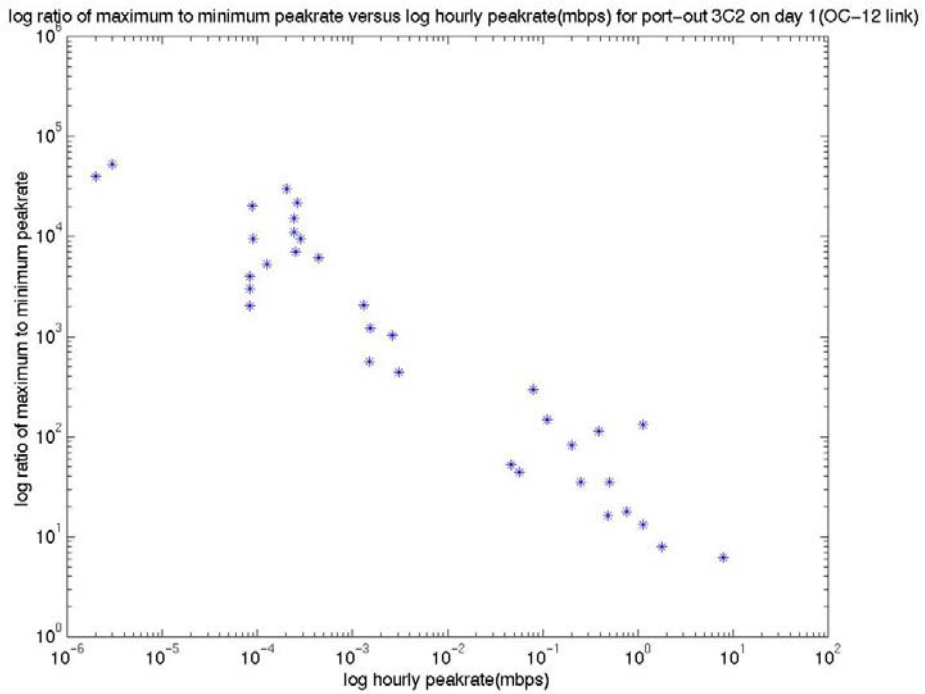

Fig.40

ratio of maximum to minimum peakrate(mbps) versus the hourly peakrate(mbps) for port-in 3C2 on day 2(OC-12 link)

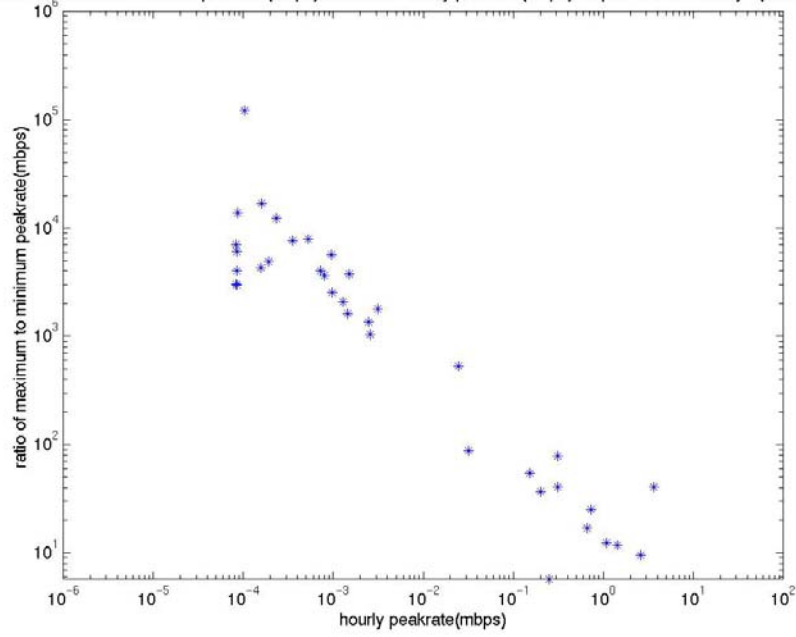

Fig.41

log ratio of maximum to minimum peakrate versus log hourly peakrate(mbps) for port-out 3C2 on day2 (OC-12 link)

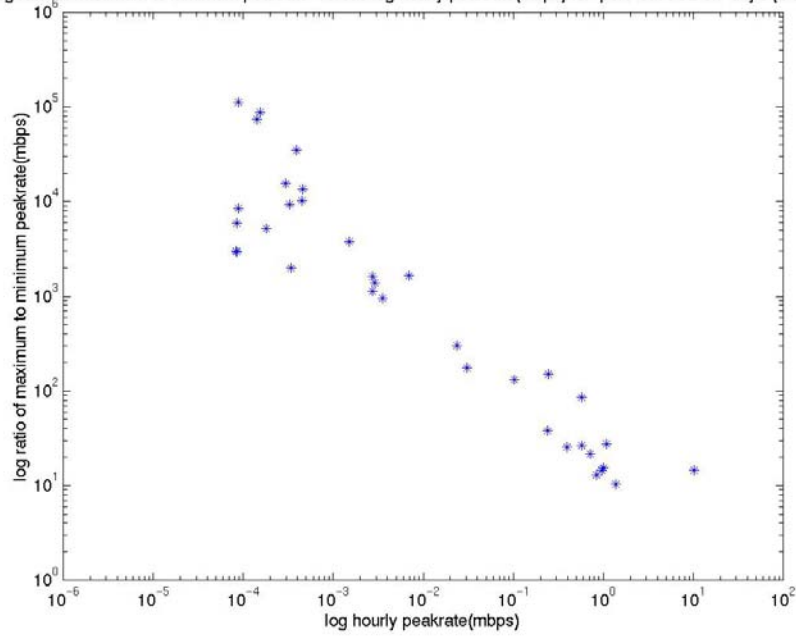

Fig.42

log ratio of maximum to minimum peakrate versus log hourly peakrate(mbps) for port-in 1A4 on day 3(OC-12 link)

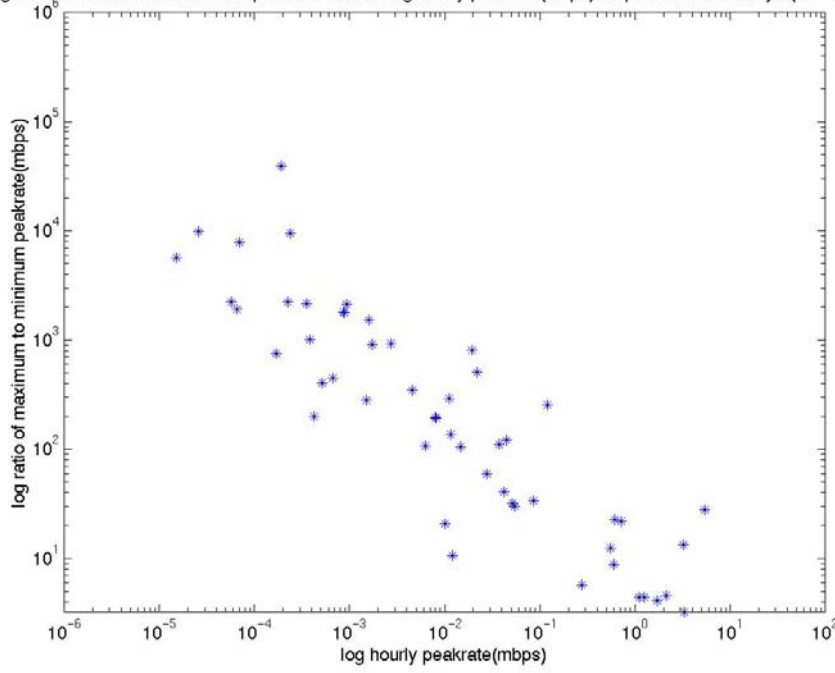

Fig.43

ratio of maximum to minimum peakrate(mbps) versus the hourly peakrate(mbps)for port-out 1A4 on day 3 (OC-12 link)

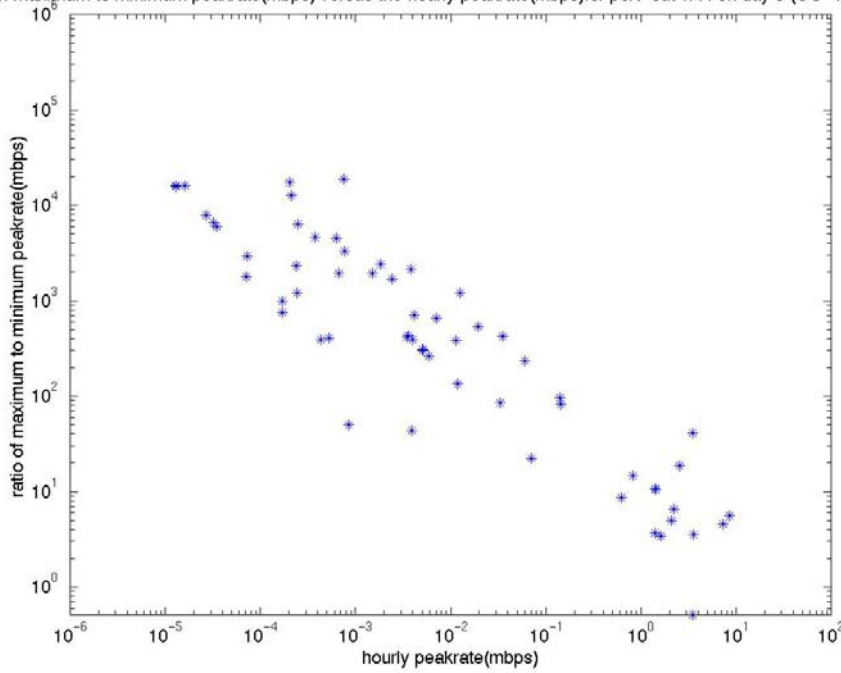

Fig.44

